

Italtrike[®]
kids on wheels

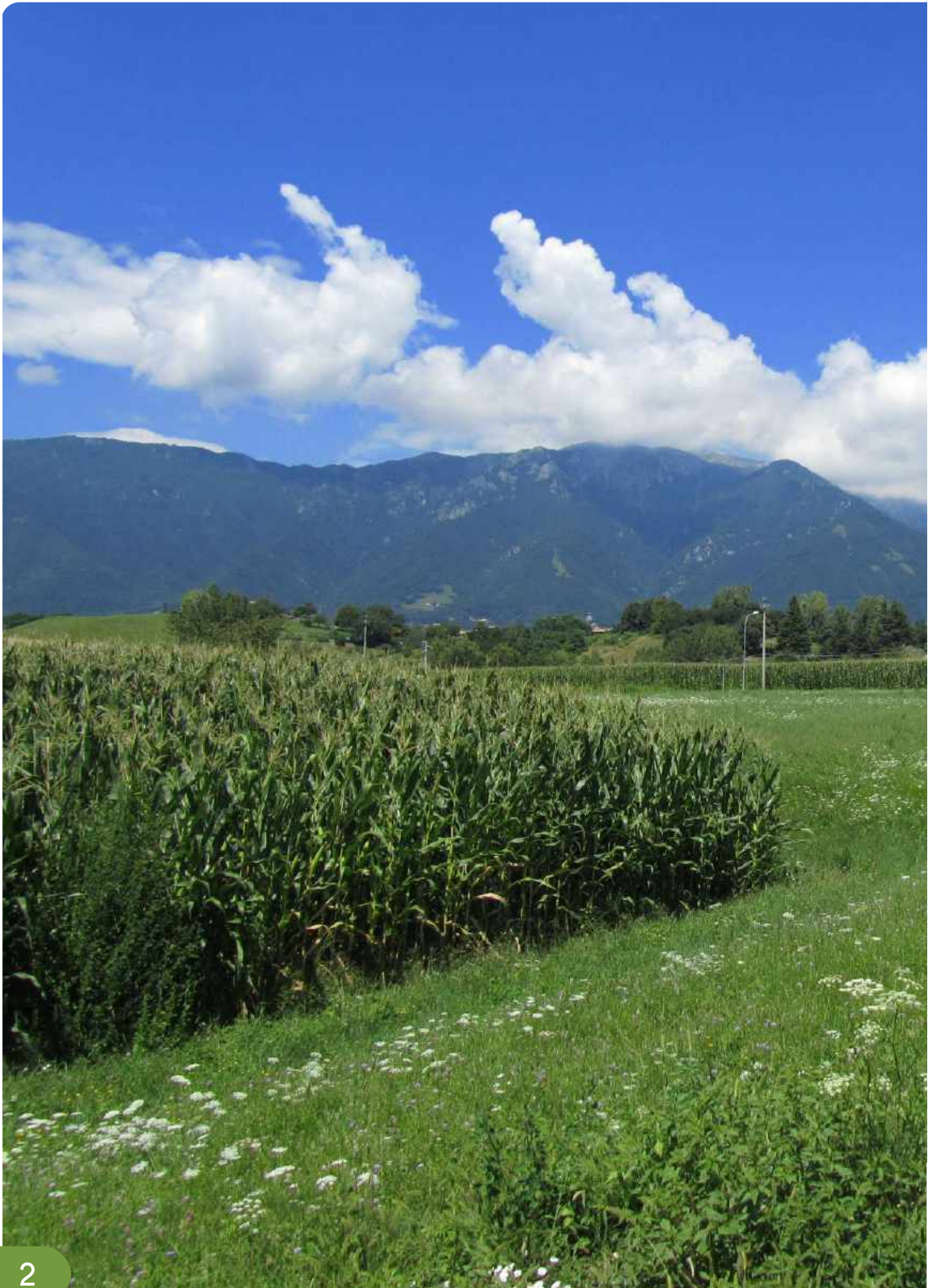

Italtrike	2 - 9
Mini eolo	10 - 21
eolo	22 - 29
Espresso	30 - 37
Alutrike	38 - 41
Pilot Line	42 - 51
Linea Rossa	52 - 63
Linea Promo	64 - 71
Zero	72 - 73
Forester	74 - 77
Village	78 - 81
La Cosa	82 - 89
Gioca	90 - 91
Spare parts	94 - 96





Italtrike Philosophy

To ride your own tricycle is an important experience for a kid. To be able to do it at school and at home represent a learning and growing moment.

Since 1983, we conceive and produce tricycles, and we have gathered during all these years a unique experience and knowledge, always at the service of our best clients : Children.

We are known all around the world through our quality projects and our exclusive design for schools and families.

Italtrike is the leader for the production of tricycle for kindergarten and communities with

a complete range of models for every age and needs.

“Kids on Wheels” is our slogan, which means that physical exercise and sport remains always the most healthy and fun activity you can offer to children.

Our tricycles are conceived and built respecting the fundamental of the European, Americans and Asian security rules.

We have also succeeded to maintain most part of our production in Italy and we will continue of doing it dedicating the same passion on this wonderful product.



Our design, Our passion

Design, engineering and children development skills are the foundation of Italtrike. To develop our products, for schools and for home as well, we work with child specialists like teachers or pediatricians.

Since more than 20 years now we work with the designer Alain Pineau that has been a part of almost all our products.

Designing a range of tricycles for children gardens doesn't allow any mistake about safety and quality, but it needs also to know and to understand a lot about children physical and cognitive development.

When we develop tricycle for special need kids, we always do it with the support of medical specialists, and therefore all our products benefits all these experiences.

We invest a lot of resources to bring the best to kids, from innovations, news materials and concepts.

Italtrike now is famous for the quality of its design , but, beyond the love of the «Grande Opera» («great work» in Italian)

Our mission is really to provide children with their first trips to freedom, to encourage them to move and develop their capabilities, motor skills and independence, to «learn to do alone» as Maria Montessori used to say.



«Cinetta»
Mini eolo line
2018



«Roberto»
Mini eolo line
2019



«La cosa 2»
2009



«Espresso»
2012

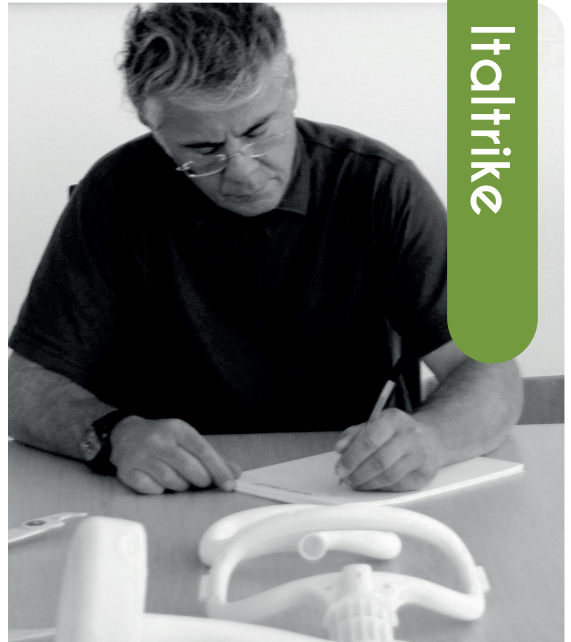

«Classic Line»
Sinse 1980



«La Cosa»
2008

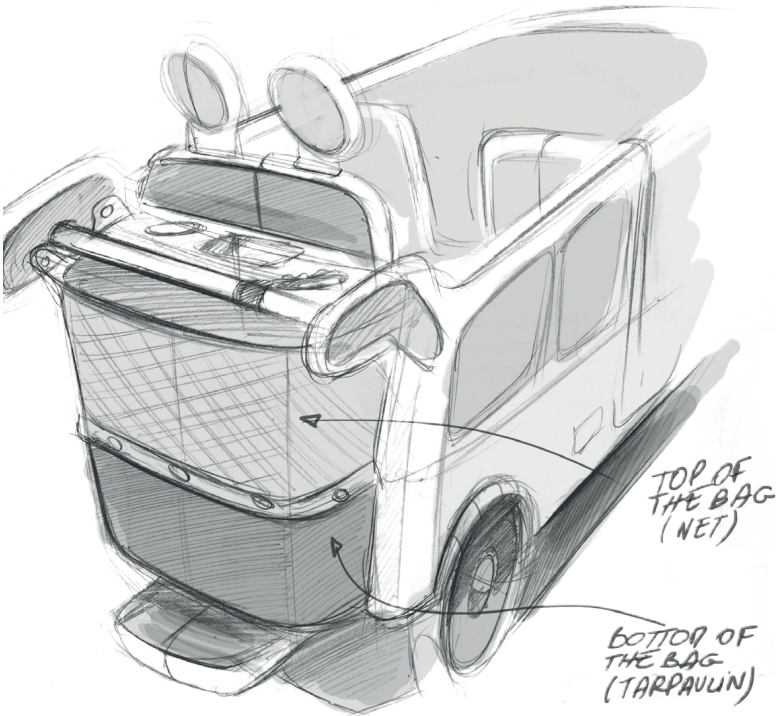

TOP OF
THE BAG
(NET)

BOTTOM OF
THE BAG
(TARPAULIN)

«abc tricycle»
presented at S. Francisco Moma in 1997
Designer: Alain Pineau, Paris



Our Sustainability

Sustainability for us is thinking about our future and the one of our children. Sustainability and respect for the environment have always been part of our identity.

We firmly believe that there is no development or progress without care and love.

It is with passion that every day we take every decision, both big and small, according to these values: to create a design and a production system that is careful and respectful. Since 2010 our company has been certified according to international standards on Environment (ISO 14001:2015), Health and Safety of workers (ISO 45001:2018). We always look out for innovative and sustainable materials, for productions processes that do not impact on the health and safety of our workers.

We produce all our products in Italy according to the circular economy concept.

We are committed to reducing our carbon footprint so to give our small users a better future.

Find out in detail the pillars of the **"Italtrike Sustainability Programme"**, which aims to bring us to zero emissions by 2030.

Discover more about it →



Local Production

95% of our components come from suppliers located less than 70km from Italtrike headquarters.



Italtrike Forest

We planted 500 trees in Guatemala in 2021 with our friends from ZERO CO2 to offset CO2 emission and support locals campesinos, And We will continue to do so.



Recycled and bio-based Materials

In addition to reducing the use of single-use plastics, we are increasing the use of recycled plastics, as we first did with "la cosa". Furthermore we are introducing bio-based plastics from wood and from cork.



Built to last

We provide replacement parts for almost all of our products, to expand their lifetime.



Product Design

We design our products to minimize their environment impact at every stage of their life cycle.



Life Cycle Assessment

We have carried out our Life Cycle Assessment with a spin-off of the University of Siena, to be constantly aware of our impact on the planet, keeping it monitored as a KPI of our target to be carbon neutral in 2030.



Renewable energy

2018 to 2020: installation of solar panels on our HQ to power production and offices.



Product Carbon Wheelprint

From 2022 we will introduce an ID Card for our products, with informations about their CO2 emissions.



Our Bravo Box packaging

We reduced our utilization of single-use plastic in our packaging by 95%. It is now made of 100% recycled and recyclable paper fiber.

Our Credits



Italtrike® has been manufacturing its school tricycles lines in Italy since the beginning. Italtrike is proud of it, of its workers and their capability and the way every day they work for the love of it. There are things that can be done only with the passion and experience gained during years of work.



In 1999 **Italtrike**® has certified its production with the standards ISO 9001 and keep on updating its quality based on the next issues to confirm that Quality is one of the first aspect controlled by the company. In 2010 Italtrike has implemented by getting the ISO 45001 Safety standards of the work place for its workers. The same year Italtrike achieved the ISO 14001 about the manufacturing process and the environmental standards. As result of that certification, Italtrike it is a factory where products are made following high quality standards, providing the maximum safety standards for its workers a dutiful environment respect.



Italtrike® gives true five years warranty on frames and forks of its tricycles. Italtrike gives also a complete range of spare parts. You can buy spares and keep your tricycle on the road for years and years. Always buy original Italtrike spare parts and keep tricycles going forever.



All **Italtrike**® tricycles and products are designed and manufactured in complete respect of the latest European and US rules in terms of Toys safety standards.



Italtrike® is Member of the Italian Toys Association.



Italtrike® has the licence ,on a certain number of products, to export to Mainland China.



GCC - Gulf Cooperation Council.

Italtrike® has been cooperating with the French Designer Alain Pineau since 1988. Alain Pineau has been able to make Italtrike's trikes to stand out in the worldwide markets thanks to the emotions and originality they transmit.

PRODUCTION CODE and Warranty terms

All Italtrike products have a Production code label.

On the label is marked a five digit code PXXXXX

By this code, Italtrike can trace the production date and its components. The new EU standards prescribes that products must have a traciability code. Italtrike has been using this system since 2005. Warranty on Italtrike products can be activated by sending the Production Code to Italtrike's quality departments together with the replacements part request.

Each replacement part is listed in this catalogue and on each assembling manual included in the tricycle box.





2015
Product: **ZERO**
Award: **Innovation**
Sector: Special Needs
Issued by: Toystore



2013
Product: **Espresso** 6 seat
Award: **Innovation**
Sector: Word on moving baby
Issued by: Kind and Jungen Fair



2018
Product: **Eolo**
Award: **Sustainable design**
Sector: Index 2018
Issued by: Index 2018



2022
Product: **eolo**
Award: selected to be **exposed in the Italian Pavilion in Dubai Expo 2020**, representing Italian excellence.

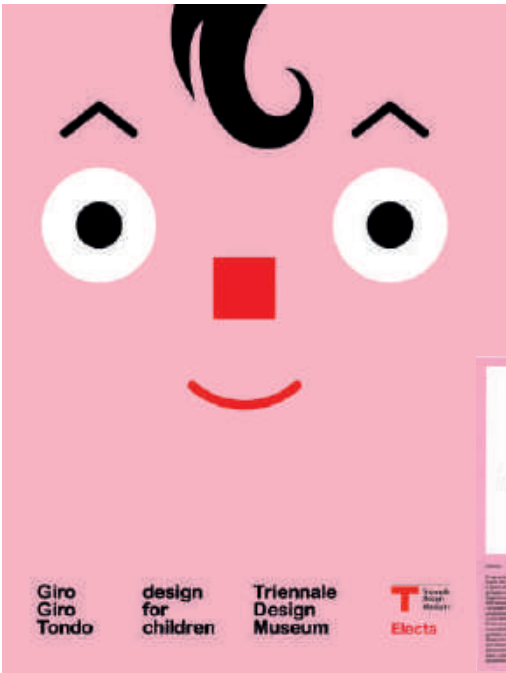
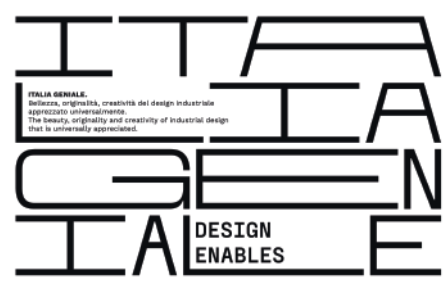

2017
Product: **La Cosa**
Exhibited at "Giro giro tondo" Exhibition, Triennale Design Museum Milan
2019
Product: **Ginetta**
Award: **Design for Kids**
Issued by: Adi Design Index 2019



minieolo

OUR EVOLUTIONARY LINE

MATERIALS

A SELECTION OF DURABLE,
RECYCLABLE AND REUSABLE
MATERIALS.

BRAVO BOX

**100% RECYCLED
AND RECYCLABLE
PAPER FIBER PACKAGING.**
REDUCED SIZE TO DECREASE
TRANSPORT POLLUTIONS.

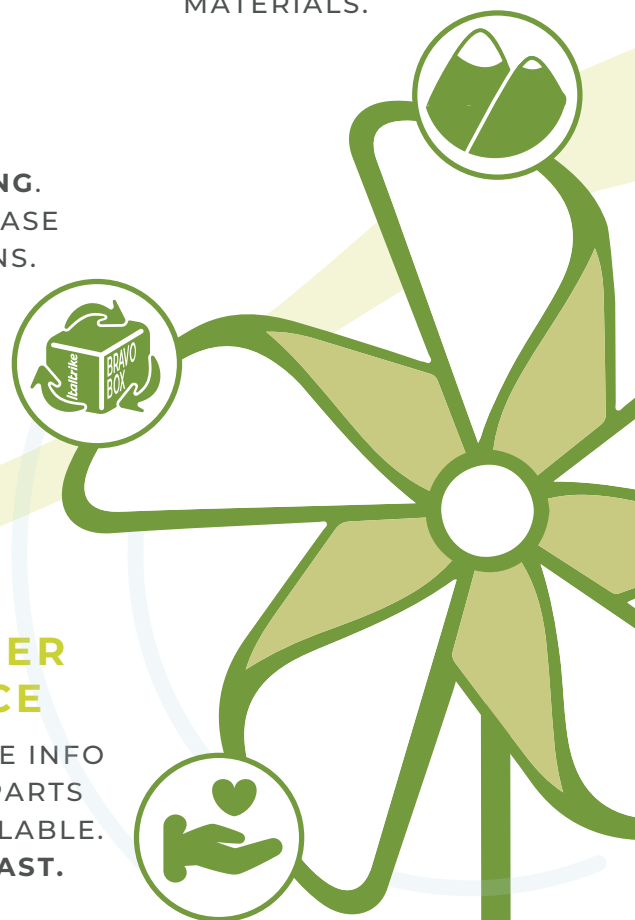

CUSTOMER SERVICE

PRODUCT CARE INFO
AND SPARE PARTS
ALWAYS AVAILABLE.
BUILT TO LAST.





PRODUCTION

LOW CARBON FOOTPRINT.
100% MADE IN ITALY.



SUSTAINABLE

DESIGN BASED ON THE
CIRCULAR ECONOMY PRINCIPLES:
EACH PRODUCT CAN BE EASILY
DISASSEMBLED AT THE END-OF-LIFE
AND SUPPLIED FOR A NEW
PRODUCTION CYCLE.



SECURITY

COMPLIANT WITH
INTERNATIONAL SAFETY
REGULATIONS.



ITALTRIKE "SAFETY-FIRST" SECURITY SYSTEMS

THE MINIEOLO LINE PRODUCTS ARE
EQUIPPED WITH SYSTEMS THAT
FURTHER INCREASE THE SAFETY
OF THE CHILD.

DESIGN

FEATURED BY LIGHT, SINUOUS AND
MODERN LINES. THEY HAVE BEEN
DESIGNED BY ALAIN PINEAU SO AS
TO BECOME ICONIC OBJECTS IN
THE TOY SCENE.

SILENT

EQUIPPED WITH RUBBER-COATED
WHEELS WHICH ARE NOISELESS AND
DO NOT DAMAGE FLOORS, EVEN
WOODEN ONES.

LIGHTWEIGHT AND STACKABLE

YOU CAN PILE ONE ON TOP OF THE
OTHER. PERFECT FOR HOME USE
AND KINDERGARTENS.

SMART

THEY ARE DELIVERED ALMOST
ASSEMBLED. WITH A "CLICK" THEY ARE
READY TO GO.
THEY REQUIRE NO MAINTENANCE,
BUT ONLY OCCASIONAL CLEANING.

REGISTERED DESIGN

GOOD LOOKING -
FUNNY TO PLAY WITH



Roberto

THEIR FIRST STEPS

ROBERTO IS A FIRST STEP SUITABLE TO ENCOURAGE CHILDREN'S BALANCE AND HELP THEIR FIRST WALKING ATTEMPTS. FOR CHILDREN FROM 10 TO MORE THAN 24 MONTHS OF AGE. IT HAS BEEN DESIGNED BY ITALTRIKE TO ENHANCE THIS IMPORTANT EXPERIENCE OF WALKING IN TOTAL SAFETY. THANKS TO ITS INNOVATIVE BALANCING AND FRICTION SYSTEM. AVAILABLE IN THREE COLOURS: LIGHT BLUE, RED AND YELLOW. JUST A CLICK AND ROBERTO IS READY TO GO.



LIGHTWEIGHT AND STACKABLE

YOU CAN PILE ONE ON TOP OF THE OTHER. PERFECT FOR HOME USE AND KINDERGARTENS.



CRASH-PROOF PLASTIC

TO AVOID SCRATCHES ON WALLS; ITS ROUNDED SHAPES DO NOT DAMAGE FURNITURE AND DOORS.

See video tutorial



RUBBER-COATED WHEELS

TO ADAPT TO ANY SURFACE WITHOUT LEAVING MARKS SUITABLE ON WOODEN FLOORS. SILENT.

LARGE HANDLEBARS SUPPORT

TO IMPROVE BALANCE.



ITALTRIKE "SAFETY-FIRST" SECURITY SYSTEMS

TWO REAR WHEEL LEVERS TO PREVENT TIPPING OVER;
TWO BRAKES TO CONTROL THE ROLLING SPEED OF THE WHEELS;
EVOLUTIONARY SYSTEMS THAT SUPPORT CHILD'S LEARNING.



Roberto
Mod. 4020

Misura prodotto / Product size	42x34x40 cm	
HxLxP	42 cm	
H. HANDLEBARS	42 cm	
Imballo / Packaging	*BRAVO BOX	
Misure/Size	21x41x37 cm	
Peso prodotto/Product weight	2.5 kg	
Peso con cartone/Shipping weight	3.6 kg	
Volume/Volume	0.04 cbm	
Età suggerita/ Recommended age	FROM 10 TO 24 MONTHS	
Peso max/Max user weight	20 kg	
Barcode	light blue	8010077402012
	red	8010077402005
	yellow	8010077402029



"Italtrike BRAVO BOX"
100% RECYCLED AND RECYCLABLE PAPER FIBER PACKAGING

Scan the QRcode for more info on our sustainability programme



Ginetta

THEIR FIRST VEHICLE

GINETTA IS A STURDY AND FUNNY RIDE-ON FOR CHILDREN (FROM 1 TO 6 YEARS OLD) WHO CAN RIDE FREELY IN TOTAL SAFETY. CHILDREN EXPERIENCE MANY DIFFERENT BALANCE SITUATIONS AND DEVELOP NEW MOTOR SKILLS. IT CAN BE USED BOTH INDOORS AND OUTDOORS. AVAILABLE IN THREE COLOURS; LIGHT BLUE, RED AND YELLOW. JUST A CLICK AND GINETTA IS READY TO GO.



See video tutorial



SMALL COMPARTMENT UNDER THE SEAT
TO STORE TOYS AND MANY OTHER THINGS.

LIGHTWEIGHT AND STACKABLE

YOU CAN PILE ONE ON TOP OF THE OTHER. PERFECT FOR HOME USE AND KINDERGARTENS.

LARGE HANDLEBARS SUPPORT

TO IMPROVE BALANCE AND FOR A CORRECT POSTURE.



ITALTRIKE "SAFETY-FIRST" SECURITY SYSTEMS

PATENTED FINGERTIP PROTECTION TO PREVENT FINGER CRUSHING.



RUBBER-COATED WHEELS

TO ADAPT TO ANY SURFACE WITHOUT LEAVING MARKS SUITABLE ON WOODEN FLOORS. SILENT.

FRONT WHEELS TURN 360°

TO EASILY MOVE IN ANY DIRECTION AND EVEN IN VERY SMALL PLACES.

ROUNDED SHAPES

TO AVOID SCRATCHES ON WALLS AND DAMAGES TO FURNITURE AND DOORS.



Ginetta

Mod. 4000

Misura prodotto / Product size

HxLxP	33x55x26.5 cm
H. HANDLEBARS	33 cm
H. SEAT	22 cm

Imballo / Packaging

Misure/Size	*BRAVO BOX
Peso prodotto/Product weight	2.5 kg
Peso con cartone/Shipping weight	4.3 kg
Volume/Volume	0.04 cbm

Età suggerita/ Recommended age



Peso max/Max user weight

50 kg

Barcode

light blue	8010077400001
red	8010077400025
yellow	8010077400018



Colour Variants
light blue - yellow - red



"Italtrike BRAVO BOX"
100% RECYCLED AND RECYCLABLE PAPER FIBER PACKAGING

Scan the QRcode for more info on our sustainability programme



Italo

THEIR FIRST CART

ITALO IS A SMALL CART WITH A CURVY DESIGN THAT SLIDES SAFELY ON EVERY SURFACE, INDOORS AND OUTDOORS. IT HELPS MANAGING SPACES, DISTANCES, MOVEMENTS AND COORDINATING CHILDREN'S WALKING. FOR CHILDREN FROM 2 TO 6 YEARS OLD. AVAILABLE IN THREE COLOURS; LIGHT BLUE RED AND YELLOW. JUST A CLICK AND ITALO IS READY TO GO.



LIGHTWEIGHT AND STACKABLE

YOU CAN PILE ONE ON TOP OF THE OTHER. PERFECT FOR HOME USE AND KINDERGARTENS.



LARGE HANDLEBARS SUPPORT

TO IMPROVE BALANCE.

LARGE LOADING COMPARTMENT
TO CARRY TOYS, FLUFFY TOYS, BOOKS AND EVERYTHING THEY WANT.



See video tutorial

ROUNDED SHAPES

TO AVOID SCRATCHES ON WALLS AND DAMAGES TO FURNITURE AND DOORS.



ITALTRIKE "SAFETY-FIRST" SECURITY SYSTEMS

PATENTED FINGERTIP PROTECTION TO PREVENT FINGER CRUSHING.



FRONT WHEELS TURN 360°

TO EASILY MOVE IN ANY DIRECTION.



RUBBER-COATED WHEELS

TO ADAPT TO ANY SURFACE WITHOUT LEAVING MARKS SUITABLE ON WOODEN FLOORS. SILENT.



Italo
Mod. 4030

Misura prodotto / Product size

HxLxP 50x54x37 cm
H. HANDLEBARS 50 cm

Imballo / Packaging

Misure/Size ***BRAVO BOX** 57x36x40 cm
Peso prodotto/Product weight 3.9 kg
Peso con cartone/Shipping weight 5.7 kg
Volume/Volume 0.082 cbm

Età suggerita/ Recommended age



Peso max/Max user weight 20 kg

Barcode
light blue 8010077403019
red 8010077403002
yellow 8010077403026



"Italtrike BRAVO BOX"
100% RECYCLED AND RECYCLABLE PAPER FIBER PACKAGING

Scan the QRcode for more info on our sustainability programme



Dino

THEIR FIRST SCOOTER

DINO IS THE **SCOOTER** FOR CHILDREN AGED **2 TO 6 YEARS**.
PERFECT FOR **MOTOR DEVELOPMENT AND LEARNING**
NEW PLAY EXPERIENCES. THE **INNOVATIVE STEERING SYSTEM**
ALLOWS CHILDREN TO MAKE WINDING TURNS BY **INTUITIVELY**
SHIFTING THEIR BODY WEIGHT SLIGHTLY TO THE RIGHT OR LEFT.
AVAILABLE IN THREE COLOURS; **LIGHT BLUE, RED AND YELLOW**.
JUST A CLICK AND DINO IS READY TO GO.



LIGHTWEIGHT AND STACKABLE

YOU CAN PILE ONE ON TOP OF THE OTHER. PERFECT FOR HOME USE AND KINDERGARTENS.

See video tutorial

LARGE HANDLEBARS SUPPORT

TO IMPROVE BALANCE AND FOR A CORRECT POSTURE.



WIDE FOOTREST

FOR GREATER SAFETY AND BODY STABILITY.



BRAKE

ITALTRIKE "SAFETY-FIRST" SECURITY SYSTEMS

FINGERTIP PROTECTION TO PREVENT FINGER CRUSHING ON BOTH BRAKING AND STEERING AXLES.



STEERING



SPECIAL STEERING SYSTEM

FOR SMOOTH BENDS SIMPLY BY SHIFTING BODY WEIGHT.

RUBBER-COATED WHEELS

TO ADAPT TO ANY SURFACE WITHOUT LEAVING MARKS. SUITABLE ON WOODEN FLOORS. SILENT.



Dino
Mod. 4040

Misura prodotto / Product size

HxLxP 62x57x32 cm
H. HANDLEBARS 62 cm

Imballo / Packaging

Misure/Size *BRAVO BOX 60x50x35 cm
Peso prodotto/Product weight 2.1 kg
Peso con cartone/Shipping weight 4 kg
Volume/Volume 0.105 cbm

Età suggerita/ Recommended age



Peso max/Max user weight 20 kg

Barcode
light blue 8010077 404023
red 8010077 404016
yellow 8010077 404030



"Italtrike BRAVO BOX"
100% RECYCLED AND RECYCLABLE PAPER FIBER PACKAGING

Scan the QRcode for more info on our sustainability programme



Board

THEIR FIRST ROLLERBOARD

BOARD IS A **ROLLERBOARD** WITH 4 LARGE 360° SWIVEL WHEELS. DESIGNED FOR CHILDREN **FROM 2 TO 8 YEARS OLD** WHO WANT TO HAVE FUN PLAYING AND DRIVING IN ANY PLACE AND IN TOTAL SAFETY. **BOARD ENHANCE BALANCE** IN MANY SITUATIONS; FROM LYING DOWN ON THE STOMACH OR SITTING DOWN PUSHING WITH HANDS RATHER THAN WITH THE STICK, JUST LIKE ROWING. AVAILABLE IN THREE COLOURS; **LIGHT BLUE RED AND YELLOW.**



LIGHTWEIGHT AND STACKABLE

YOU CAN PILE ONE ON TOP OF THE OTHER. PERFECT FOR HOME USE AND KINDERGARTENS.



EQUIPPED WITH 4 SUPPORT HANDLES

IT CAN BE USED ON EACH SIDE.



ROUNDED SHAPES

TO AVOID SCRATCHES ON WALLS AND DAMAGES TO FURNITURE AND DOORS.

RUBBER-COATED WHEELS

TO ADAPT TO ANY SURFACE WITHOUT LEAVING MARKS SUITABLE ON WOODEN FLOORS. SILENT.



4 WHEELS TURN 360°

TO EASILY MOVE IN ANY DIRECTION.

ITALTRIKE "SAFETY-FIRST" SECURITY SYSTEMS

PATENTED FINGERTIP PROTECTION TO PREVENT FINGER CRUSHING.



PADDLE (80 CM)
AVAILABLE SEPARATELY.



Board (*paddle)

Mod. 4010 Mod. 4015

Misura prodotto / Product size

HxLxP 10x63x42 cm *82x4x4 cm
H. SEAT 10 cm

Imballo / Packaging

Misure/Size 13x64x43 cm *10x10x80 cm
Peso prodotto/Product weight 3.8 kg *0.3 kg
Peso con cartone/Shipping weight 5.1 kg
Volume/Volume 0.0358 cbm

Età suggerita/ Recommended age



Peso max/Max user weight

50 kg

Barcode

light blue	8010077401015
red	8010077401008
yellow	8010077401022
*paddle	8010077401510



"Italtrike BRAVO BOX"
100% RECYCLED AND RECYCLABLE PAPER FIBER PACKAGING

Scan the QRcode for more info on our sustainability programme



What teachers say...

"Eco friendly tricycles helps promote clean living for kids in the future, as well as to help market our school to new families who know we are consistently bettering ourselves for the future."

Cathy A. Preschool teacher

"Development for the toddlers seems that they are perfectly right size and right height."

Sharon A, Preschool Teacher

"Sturdy product, especially for those learning to ride for the first time. Great means for getting around the school and playing in the environment."

California Preschool teacher





Eolo

Sustainability and Design

A school tricycle range, sustainably designed. Eolo is the new range from Italtrike.

A sturdy and solid structure that let children ride in safety in the playground.

For more than 30 years, Italtrike has been at the forefront of innovation and design, creating new technical and environmentally friendly solutions to clients all over the world.

Eolo represents an innovative approach in design, that is aesthetically pleasing and inviting to all children.

People are in the heart of everything we do and everything we produce. These same values drive our approach to sustainability. We believe we can deliver meaningful, lasting economic, environmental and social change through the choice we made and the behaviours that we demonstrate.

We have reduced energy consumption in our factory, we have completely revised the manufacturing process, re-organised packaging and logistic, and we have conceived the product's life cycle to its end.

"Eolo" TM represents an innovative approach in design, that is aesthetically pleasing and inviting to all children. Within Eolo we have placed a special attention on sustainability and green economy during the design stage.

By collaborating with Alain Pineau, his designers and engineering team, through a partnership of more than 20 years, we have actualised a product that moves as free as the wind.

Stefano Gandolfi
President



Developed for use by pre-school children, the eolo line of Tricycles and other wheeled vehicles is based on the concept of sustainability and the circular economy.

The various components making up the product are in fact assembled to each other cold and are therefore easily disassembled at the end of the life cycle to then be reinserted in a recycling phase and a new production use.

The process therefore completely eliminates any type of processing that pollutes the environment and that is detrimental to the health and safety of workers, such as welding and powder coating.

At the same time, by making the packaging volumes more compact, transport logistic are radically reduced and in addition all the various component suppliers are close to the final production site.





We create Sustainable tricycles through a lifecycle of commitments

A better Life Cycle: meaning less energy used during the manufacturing process and easy repurposing.
A selection of materials that are durables, reusable and recyclable with a lifelong quality performance and upgrade opportunities.
Improving: materials, production, transport, use and end of life.

Materials

A selection of durable, reusable and recyclable materials.

The Green Economy

100% Recyclable and detachable materials.
Easy to dispose of at the end of the product life.

Production

Low Carbon Footprint.
100% Made in Italy

Playtime

Change the size to fit the growth and development.
Available Spare parts.

Transport

Small box means less transport pollution.

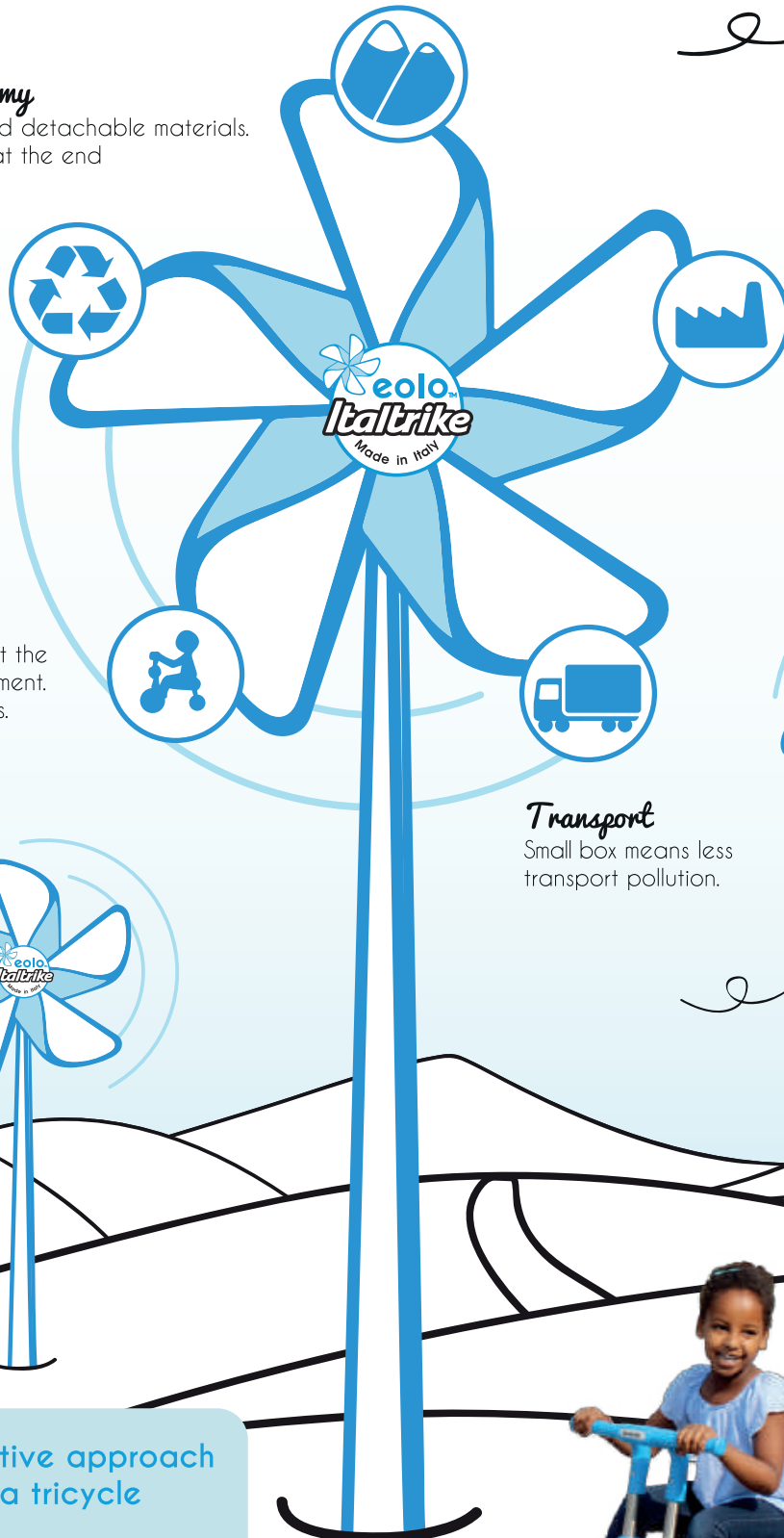

eolo, the innovative approach in the design of a tricycle

not only aesthetic lines, colours and shapes but a specific attention at sustainability values during the design phases.



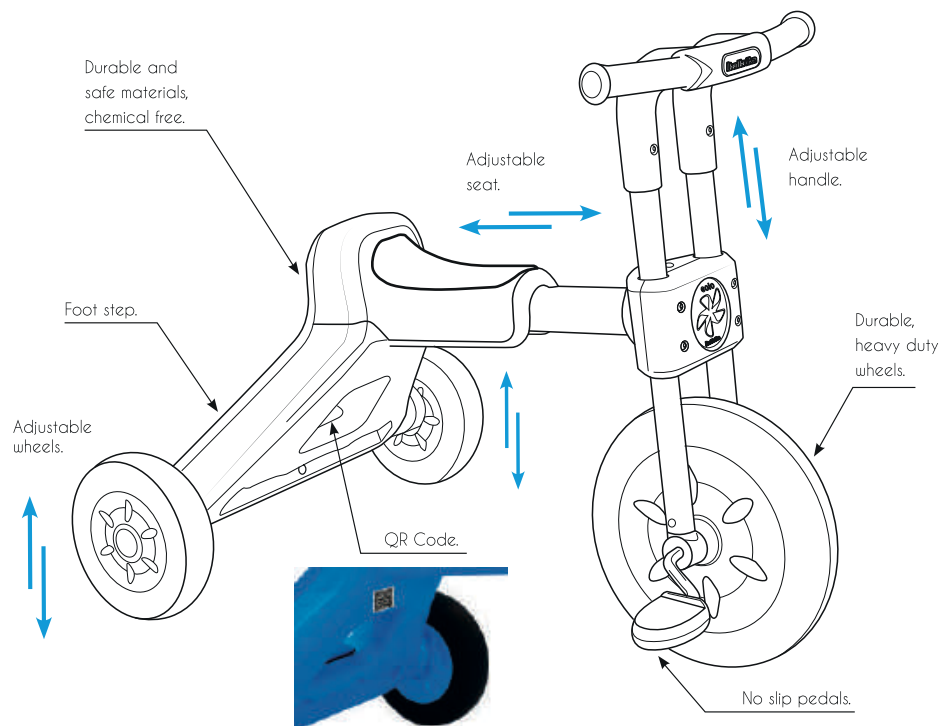

Select the correct SP for your Tricycle

- 100% Made in Italy
- 100% Recyclable
- Low Carbon Footprint

- Customer Care: spare parts service, easy assembling, see on Italtrike's Youtube Channel.
- Totally rust free

eolo Customers Care. Italtrike introduce the eolo QR code



3502-3503-3504

Assembly

When the "eolo"™ arrives at your door; you will find instructions on how to put together the tricycle in a user-friendly manner. We have designed a QR code that will be personalized to be your bike and product, and by following the code with your smartphone you will find assembly videos on YouTube, making it easier to see how to assemble your tricycle.

Replacement parts

If throughout the life of your "eolo"™ tricycle, you encounter any problems or are in need of replacement parts, simply scan the QR code that you will find on the body of the tricycle. This code will lead you to the portal to which you can order replacement parts for your tricycle and see other helpful tips from clients. Since each code will be personalized to the product type, you won't even have to remember the product code or struggle to find the informational packet that arrives with the trike on delivery.



eolo, 100% recyclable materials.

eolo



Tricycle Small

Mod. 3502

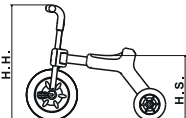

Misura prodotto / Product size

LxHxP 75x62.5x56.5 cm/29.53"x24.41"x22.24"
 H. SADDLE 35.5 cm/13.98"
 H. HANDLEBAR 62.5 cm/24.41"

Imballo / Packaging

Misure/Size 71x48.5x37.5 cm/27.95"x19.09"x14.76"
 Peso prodotto/Product weight 7.2 kg/15.84 lbs
 Peso con cartone/Shipping weight 9.8 kg/21.56 lbs
 Volume/Volume 0.129 mc/4.56 cf

Età suggerita/Suggested ages



Peso max/Max user weight 35 kg/77 lbs

Barcode 8010077350207



Tricycle Medium

Mod. 3503

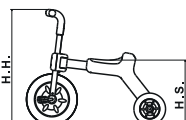

Misura prodotto / Product size

LxHxP 82x67.5x56.5 cm/32.28"x26.57"x22.24"
 H. SADDLE 38 cm/14.96"
 H. HANDLEBAR 67.5 cm/26.57"

Imballo / Packaging

Misure/Size 71x48.5x39.5 cm/27.95"x18.70"x15.55"
 Peso prodotto/Product weight 7.8 kg/17.16 lbs
 Peso con cartone/Shipping weight 9.8 kg/21.56 lbs
 Volume/Volume 0.136 mc/4.81 cf

Età suggerita/Suggested ages



Peso max/Max user weight 35 kg/77 lbs

Barcode 8010077350306



Tricycle Large

Mod. 3504

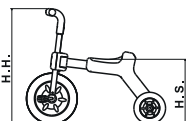

Misura prodotto / Product size

LxHxP 84x69x56.5 cm/33.07"x27.17"x22.24"
 H. SADDLE 40 cm/15.75"
 H. HANDLEBAR 69 cm/27.17"

Imballo / Packaging

Misure/Size 71x48.5x39.5 cm/27.95"x18.70"x15.55"
 Peso prodotto/Product weight 8.4 kg/18.48 lbs
 Peso con cartone/Shipping weight 10.4 kg/22.88 lbs
 Volume/Volume 0.136 mc/4.81 cf

Età suggerita/Suggested ages



Peso max/Max user weight 35 kg/77 lbs

Barcode 8010077350405



eolo, the safe and durable tricycles.



Balance Small W/O Pedal

Mod. 3508

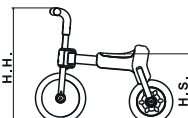

Misura prodotto / Product size

LxHxP 67x62.5x46.5 cm/26.38"x24.61"x18.31"
 H. SADDLE 36.5 cm/14.37"
 H. HANDLEBAR 62.5 cm/24.61"

Imballo / Packaging

Misure/Size 71x19x44 cm/27.95"x7.48"x17.32"
 Peso prodotto/Product weight 5.8 kg/12.76 lbs
 Peso con cartone/Shipping weight 7 kg/15.4 lbs
 Volume/Volume 0.06 mc/2.19 cf

Età suggerita/Suggested ages



Peso max/Max user weight 20 kg/44 lbs

Barcode 8010077350801



Balance Medium W/O Pedal

Mod. 3509

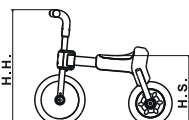

Misura prodotto / Product size

LxHxP 76.5x64.5x46.5 cm/30.12"x25.39"x18.31"
 H. SADDLE 38 cm/14.96"
 H. HANDLEBAR 64.5 cm/25.39"

Imballo / Packaging

Misure/Size 71x19x46 cm/27.95"x7.48"x18.11"
 Peso prodotto/Product weight 6.4 kg/14.08 lbs
 Peso con cartone/Shipping weight 7.5 kg/16.5 lbs
 Volume/Volume 0.06 mc/2.19 cf

Età suggerita/Suggested ages



Peso max/Max user weight 20 kg/44 lbs

Barcode 8010077350900



Balance Large W/O Pedal

Mod. 3511

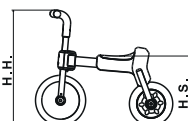

Misura prodotto / Product size

LxHxP 78x68.5x46.5 cm/30.71"x26.97"x18.31"
 H. SADDLE 40 cm/15.75"
 H. HANDLEBAR 68.5 cm/26.97"

Imballo / Packaging

Misure/Size 71x19x46 cm/27.95"x7.48"x18.11"
 Peso prodotto/Product weight 6.6 kg/14.52 lbs
 Peso con cartone/Shipping weight 7.8 kg/17.16 lbs
 Volume/Volume 0.06 mc/2.19 cf

Età suggerita/Suggested ages



Peso max/Max user weight 20 kg/44 lbs

Barcode 8010077351105



eolo, a tricycle as free as the wind.

eolo



Balance Large with Pedal

Mod. 3512

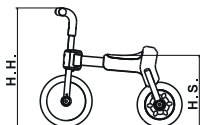

Misura prodotto / Product size

LxHxP 78x68.5x46.5 cm/30.71"x26.97"x18.31"
 H. SADDLE 40 cm/15.75"
 H. HANDLEBAR 68.5 cm/26.97"

Imballo / Packaging

Misure/Size 76.5x31x36.5 cm/30.11"x12.20"x14.37"
 Peso prodotto/Product weight 7.1 kg/15.62 lbs
 Peso con cartone/Shipping weight 8.5 kg/18.7 lbs
 Volume/Volume 0.08 mc/2.81 cf

Età suggerita/Suggested ages



Peso max/Max user weight 20 kg/44 lbs

Barcode 8010077351204



Tricycle 2 Seats

Mod. 3506

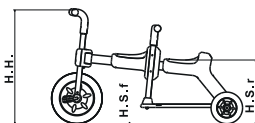

Misura prodotto / Product size

LxHxP 115x68.5x56.5 cm/45.28"x26.97"x22.24"
 H. SADDLE FRONT-REAR 41.5-38 cm/16.34"-14.96"
 H. HANDLEBAR 68.5 cm/26.97"

Imballo / Packaging

Misure/Size 96.5x48.5x48.5 cm/37.99"x19.09"x19.09"
 Peso prodotto/Product weight 11.8 kg/25.7 lbs
 Peso con cartone/Shipping weight 14.6 kg/32.12 lbs
 Volume/Volume 0.226 mc/8.03 cf

Età suggerita/Suggested ages



Peso max/Max user weight 35 kg/77 lbs

Barcode 8010077350603



Scooter Large

Mod. 3516

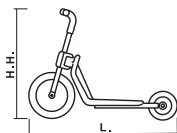

Misura prodotto / Product size

LxHxP 100x78x43 cm/39.37"x30.7"x16.93"
 H. HANDLEBAR 78 cm/30.7"

Imballo / Packaging

Misure/Size 71x19x46 cm/27.95"x7.48"x18.11"
 Peso prodotto/Product weight 6.6 kg/14.52 lbs
 Peso con cartone/Shipping weight 7.8 kg/17.16 lbs
 Volume/Volume 0.06 mc/2.19 cf

Età suggerita/Suggested ages



Peso max/Max user weight 50 kg/110 lbs

Barcode 8010077351600

Brake on Scooter

EN 71 (4.15.5.5 braking)

"Toy scooter (for children with a body mass over 20 kg) shall have at least one braking system which shall operate on rear wheel."





Espresso

Italtrike espresso products are 100% made in Italy.



3 versions : 3 different types of travelling



espresso
classico

The **Classico** version is simple and economic. Suitable for schools that are located in flat areas.

- Economic
- Push Power
- Great reliability

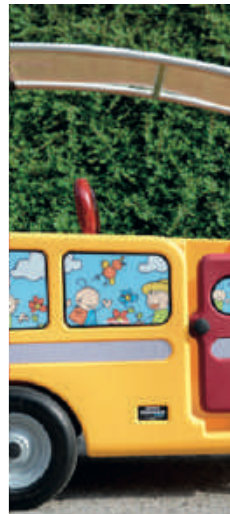

espresso
sole

The **Sole** is most ecological. A solar panel on the roof provides a natural recharge of the batteries increasing its autonomy.

- Electric Motor
- Solar Panel
- Natural Charge
- Max Autonomy



espresso
elettrico

The **Elettrico** is equipped with a powerful electric motor powered by batteries which guarantee 3 working hours. The electric traction makes a totally easy and pleasant job for the user and saves the adult every little effort.

- Electric Motor
- 2 Gel Batteries
- 3 Hours Autonomy
- User Friendly



Kind und Jugend

"espresso" Technology & Service

Espresso is 100% design and made in Italy by Italtrike. Service, spare parts, assistance can be supplied to customers within a short time.

"espresso elettrico" Teachers

We have also considered the heavy job teachers have to do in pushing 6 children on a trip. Sometimes roads are not easy, they can be on a slope or downhill, if they stop for an emergency, it can be an heavy job.

"espresso elettrico" is the right solution. They can drive the stroller by one hand, and have the complete control of the vehicle without too much stress.

We hardly recommend teachers to study the espresso manual and to practice before using it with any children onboard.

"espresso" Take a seat

The inside of espresso has been designed in such a way as to give safety and comfort to all the passengers.

Each passenger is "inside" the vehicle; a locked door allows the entrance of passengers who can reach their seat without any help. has a 3 points safety belt, and a head rest.

To give more comfort, each seat also has a washable and padded cover.

"espresso" Roof

We have a big alloy pipe structure, roll bar, on which we can fix 2 different types of roof. A sun roof and an additional transparent wall around roof to simply slip over the roll bar structure, for a total protection from wind and rain showers.

"espresso" Accessories

A large range of accessories are available :

- Sun roof, wind & rain full body roof
 - Seat pads
 - Parking cover
 - Long power batteries 70A
 - Additional 6-12 months baby seat
- And other to come...

"espresso" Structure

The body is a one piece of plastic injected with special technology from an Italian leading company in this field. It gives rigidity, durability of the product. It reflects the same constructive concept of today's body cars.

6 seated stroller, means to have aboard 6 children. "espresso" has a max load of 120 kg.

"espresso" Frame

We have a steel pipe frame connected to the body. This frame, as on the car, holds the rear wheels, brakes and wheels.

"espresso" Wheels

Wheels are very important on this kind of vehicle. We have selected big size wheels for an easy and comfortable ride. The wheels have high quality ball bearings, metal rim and high density tyres.

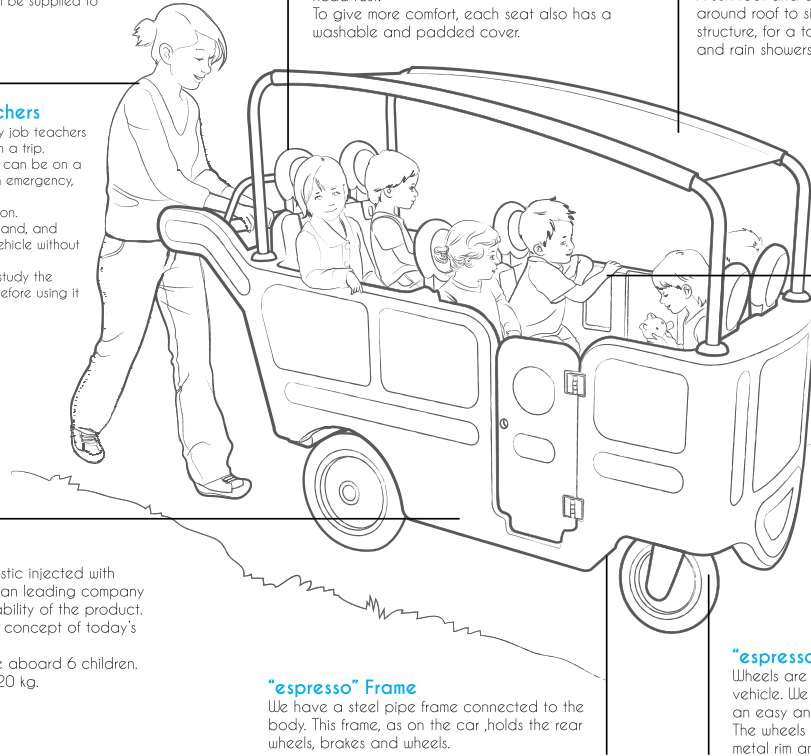



Espresso

Safety has been studied in every details in order to provide you the safest journey.



6 seats Safety First Comfort

To transport 6 children for a ride out in the countryside or in the city is not always an easy task. espresso is the solution by Italtrike. A sturdy and solid structure that protects the children while seated in their comfortable padded seats and seats belts and head rests.

Espresso illustrates the dedication on finding the perfect item that applies all the European safety standards.

The big dimension soft and solid puncture-proof wheels allows a smooth and constant utilisation in every type of roads. Now you just need to interact with the children.

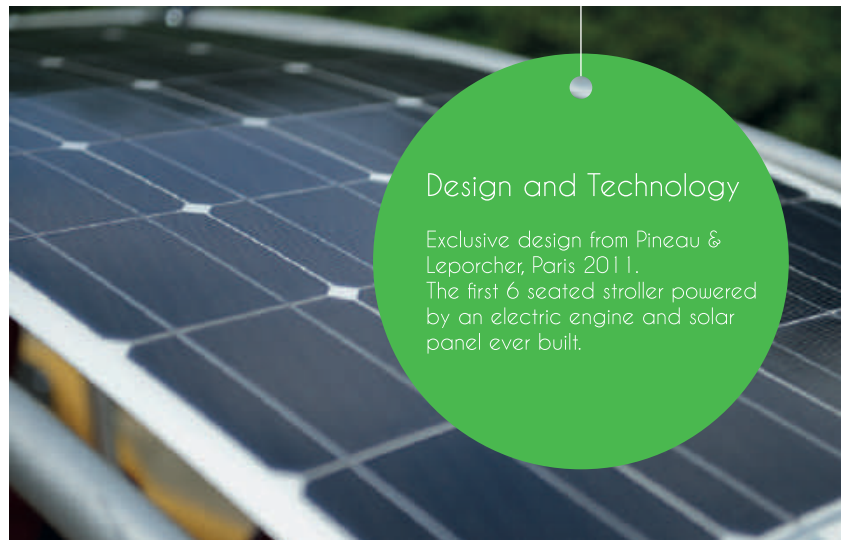

Design and Technology

Exclusive design from Pineau & Leporcher, Paris 2011.
The first 6 seated stroller powered by an electric engine and solar panel ever built.

Create personalized graphics for your espresso !

The six seated stroller espresso is proposed in two versions:
 Base
 Granturismo (GT)

On the GT version you are able to customized your espresso with the aluminium Roll-bar, sun canopy, Every espresso can be personalized with the sided panels applying special graphics. More options can be applied to complete your equipment.



Roll-bar



Stickers



Seat-pads



Cover



We have made it easier to manovrate. Now entertain children.

Very practical for children and for the adults. Manageable in every situations even the most difficult ones. Children get onboard through a sided door that only opens and closes from the outside. More options can be applied to complete your equipment.



espresso is 100% made in Italy

Espresso is "made in Italy". Italtrike provides services of spare parts and technical assistance.

Choose your own colour



Red



Green



Yellow



Cappuccino





Espresso

Comfort, we know how to do it !



Wheels

espresso wheels are soft and solid puncture-proof; their big dimension allows a smooth utilization in every type of road.



The electric version is easy to conduct; it makes easier for adults to bring kids uphill, downhill or even off road while children are comfortably seat on the espresso.

Padded comfortable washable seats, seat belts and headrests guarantees safety and comfort.

Easy to control even in difficult situations.



is our favourite number.



Children get in by themselves. They sit in their place, fasten their seat belts and are ready to go.



Difficult to feel better.
espresso elettrico



First class travel.
espresso elettrico



A nice trip out of town with friends.
espresso classico

Safety, we travel safe !



Inside the six seats stroller children will be able to really enjoy their journey in total safety, thanks to its comfortable internal cockpit structure.



Control and safety commands are transmitted to the stroller through a throttle that allows to speed up and break down naturally. Every espresso version is equipped with the breaking system that guarantees safety in every conditions.

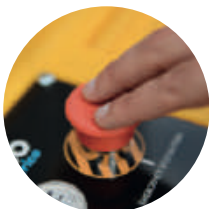

Once you release your hand from the throttle the stroller will immediately stop.



Every seat has a headrest and a 3 points safety belt.



The entrance door can be only opened from the outside.



Personalize your own Espresso:



Go to "www.espresso.italtrike.com" and built your own espresso.



Espresso

Mod. 9600

Misura prodotto / Product size

LxHxP 198x75 cm/ 77.95"x29.53"
H. 119 cm/ 46.85"

Imballo / Packaging

Misure/Size 205x80x120 cm/ 80.71"x32.50"x47.24"
Peso prodotto/Product weight 121 kg/ 266.76 lbs
Peso con cartone/Shipping weight 156 kg/ 344.6 lbs
Volume/Volume 1.97 mc/ 69.57 cf

Imballo multiplo 4pz / Master carton 4 pcs

Misure/Size 51x45x46 cm
Peso con cartone/Shipping weight 12,7 kg

Età suggerita/Suggested ages

1 6

Peso max/Max user weight 100 kg / 220.46 lbs
Passengeri/ Passengers Max 6

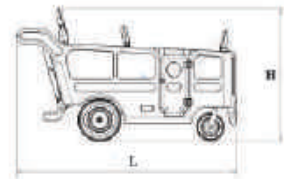

Roof Roll-bar

Mod. 9650ESP991515

Complete your espresso with the light and solid aluminium roof roll-bar. Necessary if applying the roof canopy, the rain cover and the solar panel.



Battery 60Ah

Mod. 70000

Improve the working autonomy of the espresso up to 4 hours.





Storage Product Cover

Mod. 9653ESP991500



Protect the espresso while you storage it.



Stickers Set

Mod. 179 ...



Personalize your espresso by adding your own logo or design. Stickers can also be used as advertisement.



Solar Panel (2)

Mod. 9655ESP990000



Solar panel can be only applied on the electrical version.



Seats Pads

Mod. 5114ESP ...



Washable pads, easy fit.



Sun Canopy

Mod. 9652ESP991515



Sun and UV protection. Easily fit to the roll-bar.



Rain & Wind

Mod. 9651ESP991514



In case of rain and wind the cover can easily be fixed on the roll-bar. The frontal and rear windows guarantees good air circulation.



Alutrike

ALUTRIKE is the only professional tricycle on the market. Italtrike has introduced the intensive knowledge and experience from the professional bicycles manufacturing in this line of tricycles.

Lightness, strongness, rust free made this products the best tricycle on the road !



Why alutrike



Aluminum is Light !

Compared to similar sized steel tricycles, Alutrike® is 30-35% lighter. This enables children to steer the tricycles easily and provides a more comfortable ride.

Aluminum is Strong !

New Aluminum have been developed providing greater level of strength. Additionally by creating Alutrike®, Italtrike has designed an exclusive aluminum extruded profile for its tricycle frames. The parts are hand welded by skilled and highly experienced craftsmen.

Aluminum Does Not Rust !

Painted products can be scratched and get rusted. Alutrike® products will be rust free forever. The perfect collection for areas by the sea.

alutrike Tricycle

Mod. 2001

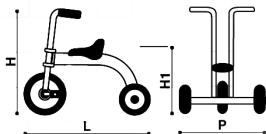

Misura prodotto / Product size

LxHxP 77.5x62.5x56.5 cm 24.8"x30.7"x22.44"
H. SADDLE 39.5 cm/15.75"

Imballo / Packaging

Misure/Size 68x40x59 cm/26.77"x15.75"x23.23"
Peso prodotto/Product weight 6,8 kg / 14.99 lbs
Peso con cartone/Shipping weight 9,0 kg / 19.84 lbs
Volume/Volume 0,155 mc/ 5.47 cf

Età suggerita/Suggested ages



Peso max/Max user weight

35 kg

Barcode

8010077200106



alutrike Tricycle 2 seats

Mod. 2002

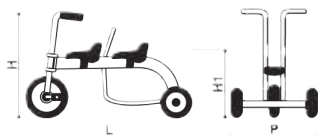

Misura prodotto / Product size

LxHxP 111x62.5x56.5cm 43.7"x24.8"x22.5"
H. SADDLE 39,5 cm/15.75"

Imballo / Packaging

Misure/Size 96x55x59 cm 37.80"x24.65"x23.23"
Peso prodotto/Product weight 8,6 kg / 18.96 lbs
Peso con cartone/Shipping weight 11,8 kg / 26.00 lbs
Volume/Volume 0,254 mc / 8.97 cf

Età suggerita/Suggested ages



Peso max/Max user weight

35 kg

Barcode

8010077200205





Alutrike

alutrike Stilts Mod. 9411

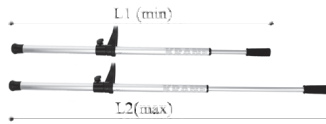

Misura prodotto / Product size	
LxHxP	110x19x10cm 43"x7.4"x3.9"
Imballo / Packaging	
Misure/Size	110x19x11cm 43"x7.4"x4.3"
Peso prodotto/Product weight	2.1kg 4.5 lbs
Peso con cartone/Shipping weight	2.65kg 5.4 lbs
Volume/Volume	0.022 mc
Età suggerita/Suggested ages	
	3 14
Peso max/Max user weight	
	35 kg
Barcode	
	8010077941108



alutrike Bike

Mod. 2005 Pu (Pu tires-Metal rims)
 Mod. 2005 Sw (solid tires)

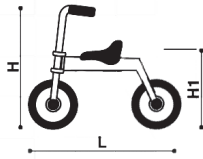

Misura prodotto / Product size
 LxHxP 63x91x51 cm 24.80"x35.83"x20.08"
 H. SADDLE 40,5 cm / 15. 94"
 H. HANDLEBAR

Imballo / Packaging
 Misura/Size 80x45x40 cm 31.50"x17.72"x15.75"
 Peso prodotto/Product weight 5,0 kg / 11.02 lbs
 Peso con cartone/Shipping weight 6,0 kg / 13.23 lbs
 Volume/Volume

Età suggerita/Suggested ages



Peso max/Max user weight 20 kg

Barcode
 Pu 8010077200502
 Asw 8010077200519

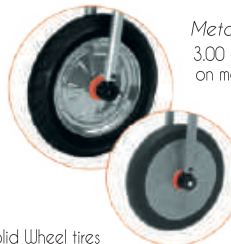

Metal wheel inflated tire
 3.00 - 4 / 260x85
 on model 2003 Pu Scooter and 2005 Pu Bike

Solid Wheel tires
 on model 2003 Sw Scooter
 and 2005 Sw Bike

alutrike Scooter

Mod. 2003 Pu (Pu tires-Metal rims)
 Mod. 2003 Sw (solid tires)

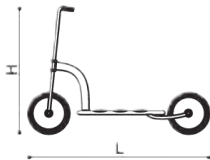

Misura prodotto / Product size
 LxHxP 88x108 cm 34.65"x42.52"

Imballo / Packaging
 Misura/Size 97x17x50 cm/ 37.80"x6.70"x19.69"
 Peso prodotto/Product weight 8,7 kg / 19.18 lbs
 Peso con cartone/Shipping weight 9,8 kg / 21.61 lbs
 Volume/Volume 0,140 mc / 4.94 cf

Età suggerita/Suggested ages



Peso max/Max user weight 20 kg/ 44 lbs

Barcode
 PU 8010077200304
 SW 8010077200311





Pilot line

Pilot Series Registered Community design n° 000496765-000 - Copyright: Pineau 2006

The Pilot Series is Italtrike the most comprehensive line. Smaller size tricycles in the Pilot 100 Serie are the perfect fit for toddlers aged 1-2 years, while preschoolers graduate, age 2-4, to the standard sized Pilot 200 Serie, and finally Pilot 300 Serie for Girls and Boys age 4-6 years.

This new commercial tricycles line has a distinctive European feel that enable to select the tricycle that best fits a child's development stage. These high quality tricycles offer all the features required to meet the high demand of child care setting. Commercial grade steel, durable finishes, outstanding workmanship and a great design which eliminates any possible pinch point.

Replacement parts are readily available. Pilot Tricycles are manufactured in Italy. Frame and forks have 5 years warranty.







Pilot line 100

Pilot 100 - Blue Trikes

Between 1 and 2 years, children start learning functions and new body movements. It is important they start their activity with a tricycle designed for them. At the beginning they start moving the tricycle just by using their feet pushing on the ground, later they start pedalling. Pilot 100 is the line dedicated to beginners age 1 to 2 years old. A good start in absolute safety and comfort.

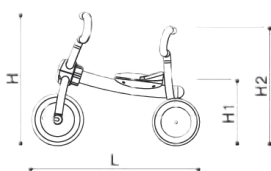

Misura prodotto / Product size	
LxHxP	55x71x45 cm 21.65"x28.00"x17.71"
H. SADDLE	26 cm / 10.23"
H. BACK HANDLEBAR	44 cm / 17.32"

Imballo / Packaging	
Misure/Size	64x47x28,5 cm 25.19"x18.5"x11.22"
Peso prodotto/Product weight	6,8 kg / 14.96 lbs
Peso con cartone/Shipping weight	8,1 kg / 17.82 lbs
Volume/Volume	0,085 mc / 3.00 cf

Età suggerita/Suggested ages		
Peso max/Max user weight		20 kg / 44 lbs
Barcode	Dyn	8010077910104
	Act	8010077910111



Straight handlebar and back rest version available on all Pilot 100 models "Dynamic"

PILOT 100 Tricycle
Mod. 100-02

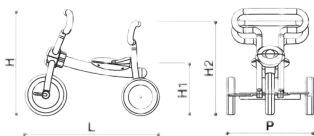

Misura prodotto / Product size

LxHxP	55x69x45 cm	21.65"x27.16"x17.71"
H. SADDLE	28 cm	11.00"
H. BACK HANDLEBAR	48 cm	18.90"

Imballo / Packaging

Misure/Size	64x47x28,5 cm	25.19"x18.5"x11.22"
Peso prodotto/Product weight	7,4 kg	16.28 lbs
Peso con cartone/Shipping weight	8,5 kg	17.74 lbs
Volume/Volume	0,085 mc	3.00 cf

Età suggerita/Suggested ages

Peso max/Max user weight	20 kg	44 lbs
Barcode	Dyn	8010077910203
	Act	9010077910210



PILOT 100 Walker for 2
Mod. 100-03

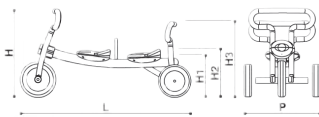

Misura prodotto / Product size

LxHxP	55x102x45 cm	21.65"x40.15"x17.71"
H. SADDLE	28 cm	10.23"
H. BACK SADDLE	26 cm	10.23"
H. BACK HANDLEBAR	44 cm	17.32"

Imballo / Packaging

Misure/Size	92x46x34 cm	36.22"x18.11"x13.38"
Peso prodotto/Product weight	7,8 kg	17.16 lbs
Peso con cartone/Shipping weight	9,8 kg	21.56 lbs
Volume/Volume	0,144 mc	5.08 cf

Età suggerita/Suggested ages

Peso max/Max user weight	20 kg	44 lbs
Barcode	Dyn	8010077910302
	Act	9010077910319



PILOT 100 Wheels Scooter
Mod. 100-04

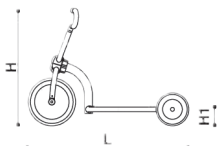

Misura prodotto / Product size

LxHxP	70x88x41 cm	27.55"x34.64"x16.14"
H.1	10 cm	3.93"

Imballo / Packaging

Misure/Size	75x51x37 cm	29.52"x20.07"x14.56"
Peso prodotto/Product weight	6,8 kg	14.96 lbs
Peso con cartone/Shipping weight	8,6 kg	18.92 lbs
Volume/Volume	0,141 mc	5.00 cf

Età suggerita/Suggested ages

Peso max/Max user weight	20 kg	44 lbs
Barcode	Dyn	8010077910401
	Act	9010077910418





Pilot line 200

Pilot 200 - Orange Tricycles

Pilot 200 is the tricycles line designed for children from 2 to 4 years old. At this age, kids are more confident with their own capabilities, and they need more appropriated vehicles for their rides. They deserve a tricycle to ride alone and discover the freedom, a tricycle for 2 to ride a friend around and a 2 wheels scooter to improve equilibrium and their fun.

PILOT 200 Walker Mod. 200-20

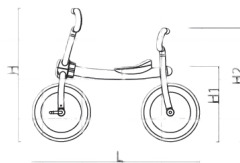

Misura prodotto / Product size	
LxHxP	60x79 cm 23.62"x31.10"
H. SADDLE	37 cm / 14.50"
H. BACK HANDLEBAR	58 cm / 22.80"

Imballo / Packaging	
Misure/Size	64x47x28,5 cm 25.99"x18.50"x11.22"
Peso prodotto/Product weight	9,2 kg / 20.24 lbs
Peso con cartone/Shipping weight	10,3 kg / 22.96 lbs
Volume/Volume	0,085 mc/ 3.00 cf

Età suggerita/Suggested ages		2 4
Peso max/Max user weight	20 kg / 44 lbs	
Barcode	Dyn	8010077922008
	Act	8010077922015



PILOT 200 Tricycle Mod. 200-07

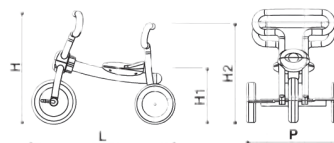

Misura prodotto / Product size	
LxHxP	58x73x57 cm 22.80"x28.70"x22.40"
H. SADDLE	35 cm / 13.70"
H. BACK HANDLEBAR	56 cm / 22.00"

Imballo / Packaging	
Misure/Size	57x67x36 cm 22.40"x26.37"x14.17"
Peso prodotto/Product weight	10,0 kg / 22.00 lbs
Peso con cartone/Shipping weight	11,8 kg / 26.07 lbs
Volume/Volume	0,137 mc/ 4.85 cf

Età suggerita/Suggested ages		2 4
Peso max/Max user weight	35 kg / 77 lbs	
Barcode	Dyn	8010077920707
	Act	8010077920714



Straight handlebar and back rest version available on all Pilot 200 models
"Dynamic"



Be Tricycle

Mod. 200-10

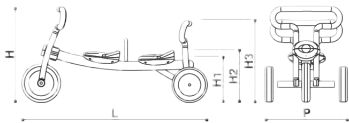

Misura prodotto / Product size

LxHxP	61,5x108x57 cm	40.16"x22.83"x16.93"
H. SADDLE		37 cm / 14.50"
H. BACK HANDLEBAR		58 cm / 22.80"

Imballo / Packaging

Misure/Size	102x58x43 cm	40.16"x22.83"x16.93"
Peso prodotto/Product weight		13,5 kg / 19.18 lbs
Peso con cartone/Shipping weight		16,25 kg / 35.75 lbs
Volume/Volume		0,254 mc / 8.98 cf

Età suggerita/Suggested ages



Peso max/Max user weight		35 kg / 77 lbs
--------------------------	--	----------------

Barcode	Dyn	8010077921001
	Act	8010077921018



Scoter

Mod. 200-11

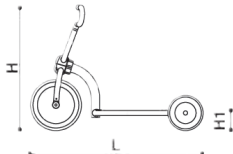

Misura prodotto / Product size

LxHxP	71x90 cm	27.90"x35.40"
H ₁		11 cm / 4.33"

Imballo / Packaging

Misure/Size	92x42x28cm	36.2"x16.53"x11"
Peso prodotto/Product weight		7kg / 15.43lbs
Peso con cartone/Shipping weight		8,5kg / 18.73lbs
Volume/Volume		0,137 mc / 4.85 cf

Età suggerita/Suggested ages



Peso max/Max user weight		20 kg / 44 lbs
--------------------------	--	----------------

Barcode	Dyn	8010077921100
	Act	8010077921117



Bike

Mod. 200-17

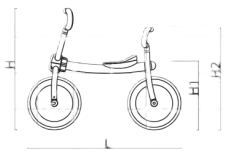

Misura prodotto / Product size

LxHxP	60x79 cm	23.62"x31.10"
H.SADDLE		37 cm / 14.50"
H.BACK HANDLEBAR		58 cm / 22.80"

Imballo / Packaging

Misure/Size	64x47x28.5 cm	25.99"x18.50"x11.22"
Peso prodotto/Product weight		9,5 kg / 20.94 lbs
Peso con cartone/Shipping weight		10,5 kg / 23.15 lbs
Volume/Volume		0,085 mc / 3.00 cf

Età suggerita/Suggested ages



Peso max/Max user weight		20 kg / 44 lbs
--------------------------	--	----------------

Barcode	Dyn	8010077921704
	Act	8010077921711





Pilot line 300

Pilot 300 - Yellow Tricycles

For young girls and boys, age 4 to 6 years old. They are skilled and they want a real and smart vehicle to ride with.



PILOT 300 Bike Mod. 300-17

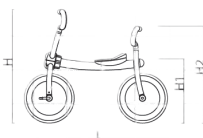

Misura prodotto / Product size	
LxHxP	69x90 cm 27.16"x35.43"
H. SADDLE	38 cm / 14.96"
H. BACK HANDLEBAR	60 cm / 23.62"

Imballo / Packaging	
Misure/Size	75x51x37 cm 29.52"x20.07"x14.56"
Peso prodotto/Product weight	9,8 kg / 21.56 lbs
Peso con cartone/Shipping weight	11,5 kg / 25.30 lbs
Volume/Volume	0,141 mc / 5.00 cf

Età suggerita/Suggested ages	
4 6	
Peso max/Max user weight	20 kg / 44 lbs
Barcode	
Dyn	8010077931710
Act	8010077931703



PILOT 300 Tricycle Mod. 300-14

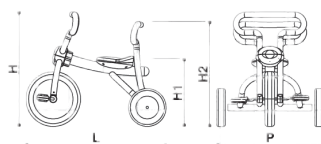

Misura prodotto / Product size	
LxHxP	69x82x57 cm 27.16"x32.28"x22.40"
H. SADDLE	40 cm / 15.74"
H. BACK HANDLEBAR	58 cm / 22.83"

Imballo / Packaging	
Misure/Size	87x57x37 cm 31.49"x22.44"x14.56"
Peso prodotto/Product weight	11,0 kg / 24.20 lbs
Peso con cartone/Shipping weight	13,3 kg / 29.15 lbs
Volume/Volume	0,168 mc / 5.95 cf

Età suggerita/Suggested ages	
4 6	
Peso max/Max user weight	35 kg / 77 lbs
Barcode	
Dyn	8010077931413
Act	8010077931406



Straight handlebar and back rest version available on all Pilot 300 models "Dynamic"

PILOT 300 **Be Tricycle**
Mod. 300-15

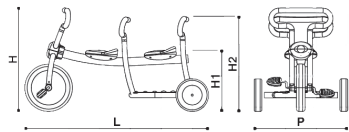

Misura prodotto / Product size
LxHxP 69x117x56 cm 27.16"x46.06"x22.04"
H. SADDLE 40 cm / 15.74"
H. BACK HANDLEBAR 61 cm / 20.01"

Imballo / Packaging
Misure/Size 102x58x43 cm 40.16"x22.83"x16.93"
Peso prodotto/Product weight 15,0 kg / 33.00 lbs
Peso con cartone/Shipping weight 16,5 kg / 36.30 lbs
Volume/Volume 0,254 mc/ 8.98 cf

Età suggerita/Suggested ages **4 6**
Peso max/Max user weight 35 kg / 77 lbs
Barcode Dyn 8010077931512
Act 8010077931505



PILOT 300 **Scooter**
Mod. 300-18

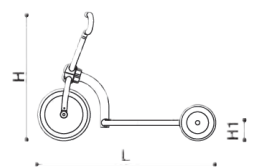

Misura prodotto / Product size
LxHxP 80x109 cm 31.50"x42.91"
H.1 37 cm / 14.50"

Imballo / Packaging
Misure/Size 92x39x29 cm 36.22"x15.35"x14.41"
Peso prodotto/Product weight 7,8 kg / 17.16 lbs
Peso con cartone/Shipping weight 9,6 kg / 21.14 lbs
Volume/Volume 0,104 mc/ 3.67 cf

Età suggerita/Suggested ages **4 6**
Peso max/Max user weight 50 kg / 110 lbs
Barcode Dyn 8010077931819
Act 8010077931802

Brake on Scooter
EN 71 (4.15.5.5 braking)
"Toy scooter (for children with a body mass over 20 kg) shall have at least one braking system which shall operate on rear wheel..."



PILOT 300 **Scooter 3 Wheels**
Mod. 300-21

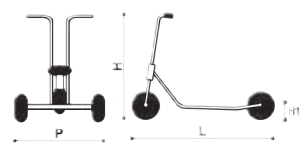

Misura prodotto / Product size
LxHxP 70x93x61 cm 28.00"x37.00"x24.00"
H.1

Imballo / Packaging
Misure/Size 60x65x30 cm 23.62"x25.60"x11.81"
Peso prodotto/Product weight 8,2 kg / 18.00 lbs
Peso con cartone/Shipping weight 8,9 kg / 19.62 lbs
Volume/Volume 0,120 mc/ 4.23 cf

Età suggerita/Suggested ages **3 6**
Peso max/Max user weight 20 kg / 44 lbs
Barcode Dyn 8010077932106
Act 8010077932113





Pilot line Trucks



School Bus Fire Truck Police

Mod. 300-19

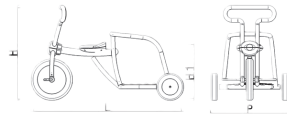

Misura prodotto / Product size
LxHxP 69x114x56 cm 27.16"x44.88"x22.04"
H. SADDLE 39 cm / 15.35"

Imballo / Packaging
Misure/Size 102x58x43 cm 40.16"x22.83"x16.93"
Peso prodotto/Product weight 12,6 kg / 27.70 lbs
Peso con cartone/Shipping weight 14 kg / 30.80 lbs
Volume/Volume 0,254 mc / 8.98 cf

Età suggerita/Suggested ages 4 6
Peso max/Max user weight 35 kg / 77 lbs



School Bus

Mod. 300-19 SB

Barcode
Dyn 8010077931918
Act 8010077931901



Fire Truck

Mod. 300-19 FT

Barcode
Dyn 8010077931932
Act 8010077931925



Police

Mod. 300-19 PO

Barcode
Dyn 8010077931918
Act 8010077931901



Straight handlebar and back rest version available on all Pilot 300 models "Dynamic"

PILOT 300 Taxi 1+2 back seats
Mod. 309-19 (1+2)

Misura prodotto / Product size

LxHxP	72x116x92 cm	28.35"x45.67"x36.22"
H. SADDLE		39 cm / 15.35"
H. 2		113 cm / 44.49"

Imballo / Packaging

Misure/Size	60x95x72 cm	23.62"x37.40"x28.35"
Peso prodotto/Product weight		22,4 kg / 49,38 lbs
Peso con cartone/Shipping weight		25,0 kg / 55,11 lbs
Volume/Volume		0,410 mc / 14,48 cf

Età suggerita/Suggested ages

4 6

Peso max/Max user weight		35 kg / 77 lbs
Barcode	Dyn	8010077939143
	Act	8010077939150



2 passenger seats

PILOT 300 Taxi 1+1 rear seat
Mod. 300-19 (1+1)



Misura prodotto / Product size

LxHxP	72x114x63 cm	28.35"x44.88"x24.80"
H. SADDLE		39 cm / 15.35"
H. 2		113 cm / 44.49"

Imballo / Packaging

Misure/Size	108x58x49 cm	42.52"x22.83"x19.29"
Peso prodotto/Product weight		16,8 kg / 37,04 lbs
Peso con cartone/Shipping weight		20,6 kg / 45,42 lbs
Volume/Volume		0,306 mc / 10,80 cf

Età suggerita/Suggested ages

4 6

Peso max/Max user weight		35 kg / 77 lbs
Barcode	Dyn	8010077939148
	Act	8010077939150



PILOT 300 Fire Truck 1+1 rear seat
Mod. 300-19 FT (1+1)



Misura prodotto / Product size

LxHxP	72x114x63 cm	28.35"x44.88"x24.80"
H. SADDLE		39 cm / 15.35"
H. 2		113 cm / 44.49"

Imballo / Packaging

Misure/Size	108x58x49 cm	42.52"x22.83"x19.29"
Peso prodotto/Product weight		16,8 kg / 37,04 lbs
Peso con cartone/Shipping weight		20,6 kg / 45,42 lbs
Volume/Volume		0,306 mc / 10,80 cf

Età suggerita/Suggested ages

4 6

Peso max/Max user weight		35 kg / 77 lbs
Barcode	Dyn	8010077939167
	Act	8010077939174





Tricycle with Chain

Mod. 9056

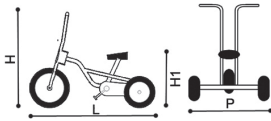

Misura prodotto / Product size

LxHxP	68x85x48 cm	26.77"x33.46"x18.89"
H. I		39 cm / 15.35"
H. II		46 cm / 18.11"

Imballo / Packaging

Misure/Size	67x53x40 cm	26.38"x20.87"x15.75"
Peso prodotto/Product weight		10,0 kg / 22.05 lbs
Peso con cartone/Shipping weight		11,8 kg / 26.01 lbs
Volume/Volume		0,14 mc / 4.94 cf

Età suggerita/Suggested ages



Peso max/Max user weight	25 kg / 55.12 lbs
--------------------------	-------------------

Barcode	8010077905605
----------------	---------------



Steering limit



Safe chain cover



Padded & adjustable seat



Heavy duty Transmissions System



Speedy

Mod. 9001

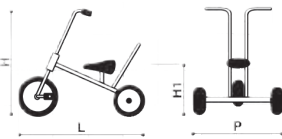

Misura prodotto / Product size

LxHxP	60,5x69x49 cm	23.81"x27.17"x19.29"
H. SADDLE		32 cm / 12.60"

Imballo / Packaging

Misure/Size	62x40x51 cm	24.41"x15.75"x20.08"
Peso prodotto/Product weight		8,0 kg / 17.64 lbs
Peso con cartone/Shipping weight		9,6 kg / 21.16 lbs
Volume/Volume		0,130 mc / 4.59 cf

Età suggerita/Suggested ages



Peso max/Max user weight	35 kg / 77 lbs
--------------------------	----------------

Barcode	8010077900105
----------------	---------------



Carry

Mod. 9002

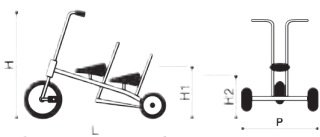

Misura prodotto / Product size

LxHxP	60,5x92x49 cm	24.02"x36.22"x19.29"
H. SADDLE I		39,5 cm / 15.75"
H. SADDLE II		36,5 cm / 14.57"

Imballo / Packaging

Misure/Size	79x45x51 cm	31.10"x17.72"x20.08"
Peso prodotto/Product weight		10,6 kg / 23.37 lbs
Peso con cartone/Shipping weight		12,6 kg / 27.8 lbs
Volume/Volume		0,190 mc / 6.71 cf

Età suggerita/Suggested ages



Peso max/Max user weight	35 kg / 77 lbs
--------------------------	----------------

Barcode	8010077900204
----------------	---------------





Linea Rossa





Big Carry

Mod. 9010

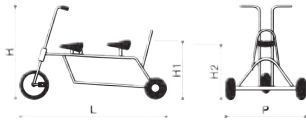

Misura prodotto / Product size

LxHxP	72,5x118x62 cm 28.54"x46.46"x24.41"
H. SADDLE I	49 cm / 19.29"
H. SADDLE II	50 cm / 19.69"

Imballo / Packaging

Misure/Size	46x101,5x62 cm 18.12"x39.96"x24.61"
Peso prodotto/Product weight	13,6 kg / 29.98 lbs
Peso con cartone/Shipping weight	16,2 kg / 35.71 lbs
Volume/Volume	0,300 mc / 10.59 cf

Età suggerita/Suggested ages



Peso max/Max user weight	35 kg / 77 lbs
--------------------------	----------------

Barcode	8010077901003
----------------	---------------



Triply

Mod. 9060

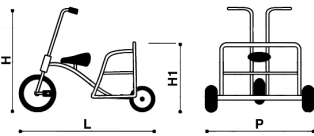

Misura prodotto / Product size

LxHxP	67x98x92 cm 26.38"x35.58"x36.22"
H. SADDLE	49 cm / 19.29"

Imballo / Packaging

Misure/Size	85x100x50 cm 33.46"x39.37"x19.68"
Peso prodotto/Product weight	14,5 kg / 31.97 lbs
Peso con cartone/Shipping weight	16 kg / 35.27 lbs
Volume/Volume	

Età suggerita/Suggested ages



Peso max/Max user weight	35 kg / 77 lbs
--------------------------	----------------

Barcode	8010077906008
----------------	---------------



Quickly

Mod. 9003

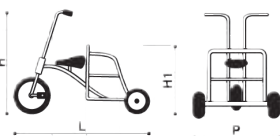

Misura prodotto / Product size

LxHxP	60,5x92x49 cm 23.81"x36.22"x19.29"
H. SADDLE	37 cm / 14.57"

Imballo / Packaging

Misure/Size	79x51x45 cm 31.10"x20.07"x17.71"
Peso prodotto/Product weight	11 kg / 24.25 lbs
Peso con cartone/Shipping weight	13 kg / 28.66 lbs
Volume/Volume	0,19 mc / 6.71 cf

Età suggerita/Suggested ages



Peso max/Max user weight	35 kg / 77 lbs
--------------------------	----------------

Barcode	8010077900303
----------------	---------------





linea Rossa



Scooter

Mod. 9004

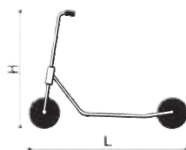

Misura prodotto / Product size

LxHxP 66,5x97 cm 24.02"x38.19"

Imballo / Packaging

Misure/Size 82x20x44 cm 32.28"x7.87"x17.32"

Peso prodotto/Product weight 5,6 kg / 12.35 lbs

Peso con cartone/Shipping weight 6,6 kg / 14.55 lbs

Volume/Volume 0,080 mc / 2.83 cf

Età suggerita/Suggested ages



Peso max/Max user weight 20 kg / 44 lbs

Barcode 8010077900402



Scooter 3 Wheels Solid

Mod. 9053

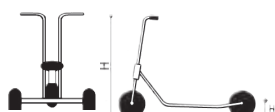

Misura prodotto / Product size

LxHxP 70x93x61 cm 28.00"x37.00"x24.00"

Imballo / Packaging

Misure/Size 60x65x30 cm 23.62"x25.60"x11.81"

Peso prodotto/Product weight 8,2 kg / 18.00 lbs

Peso con cartone/Shipping weight 8,9 kg / 19.62 lbs

Volume/Volume 0,120 mc / 4.23 cf

Età suggerita/Suggested ages



Peso max/Max user weight 20 kg / 44 lbs

Barcode 8010077905391





Scooter 3 Wheels

Mod. 9061

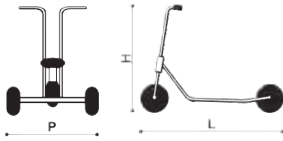

Misura prodotto / Product size

LxHxP 55x68x44 cm 21.65"x26.77"x17.32"
H. SADDLE 32 cm / 15.75"

Imballo / Packaging

Misure/Size 51x57,5x27 cm 20.08"x22.64"x10.63"
Peso prodotto/Product weight 6,4 kg / 14.11 lbs
Peso con cartone/Shipping weight 7,1 kg / 15.65 lbs
Volume/Volume 0,080 mc / 2.82 cf

Età suggerita/Suggested ages



Peso max/Max user weight 35 kg / 77 lbs

Barcode 8010077906107



Scooter Pu Tires

Mod. 9007 & 9008

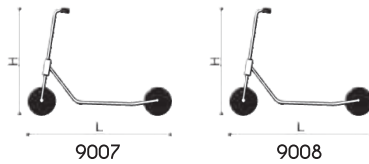

9007

9008

Misura prodotto / Product size

LxHxP 71,5x104 cm 28.15"x40.95" 86,5x104 cm 34.05"x40.95"

Imballo / Packaging

Misure/Size	92x29x38 cm 36.22"x11.42"x14.96"	92x29x38 cm 36.22"x11.42"x14.96"
Peso prodotto/Product weight	7,0 kg / 15.43 lbs	7,2 kg / 15.87 lbs
Peso con cartone/Shipping weight	8,5 kg / 18.74 lbs	8,7 kg / 19.18 lbs
Volume/Volume	0,110 mc / 3.88 cf	0,110 mc / 3.88 cf

Età suggerita/Suggested ages



Peso max/Max user weight 50 kg / 110 lbs 50 kg / 110 lbs

Barcode 8010077900709 8010077900808

Brake on Scooter
EN 71 (4.15.5.5 braking)
"Toy scooter (for children with a body mass over 20 kg) shall have at least one braking system which shall operate on rear wheel..."



Mod. 9008

Mod. 9007



Scooter 3 Wheels Pu Tires

Mod. 9050 & 9051

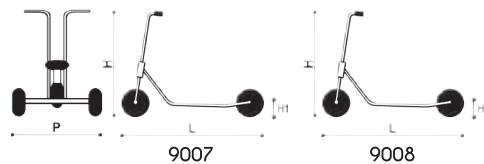

9007

9008

Misura prodotto / Product size

LxHxP 71,5x85x67 cm 28.15"x33.50"x26.38" 86,5x85x67 cm 34.05"x33.50"x26.38"
H 1 6 cm / 2.36" 6 cm / 2.36"

Imballo / Packaging

Misure/Size	61,5x75x42 cm 24.21"x29.53"x16.54"	61,5x75x42 cm 24.21"x29.53"x16.54"
Peso prodotto/Product weight	8,2 kg / 18 lbs	8,2 kg / 18 lbs
Peso con cartone/Shipping weight	9,6 kg / 21.12 lbs	9,6 kg / 21.12 lbs
Volume/Volume	0,194 mc / 6.85 cf	0,194 mc / 6.85 cf

Età suggerita/Suggested ages



Peso max/Max user weight 20 kg / 44 lbs 20 kg / 44 lbs

Barcode 8010077905001 8010077905100



Mod. 9051

Mod. 9050



Linea Rossa



Rishow Pu Tires

Mod. 9030



Misura prodotto / Product size

L x H x P 54x155x65 cm 21.25"x61.05"x25.39"
H. SEAT 28,5 cm / 11.22"

Imballo / Packaging

Misure/Size 46x65x80 cm 18.11"x25.59"x31.50"
Peso prodotto/Product weight 9,6 kg / 21.12 lbs
Peso con cartone/Shipping weight 11,0 kg / 24.20 lbs
Volume/Volume 0,239 mc/ 8.47 cf

Età suggerita/Suggested ages

4 8

Peso max/Max user weight 35 kg / 77 lbs

Barcode 8010077903007

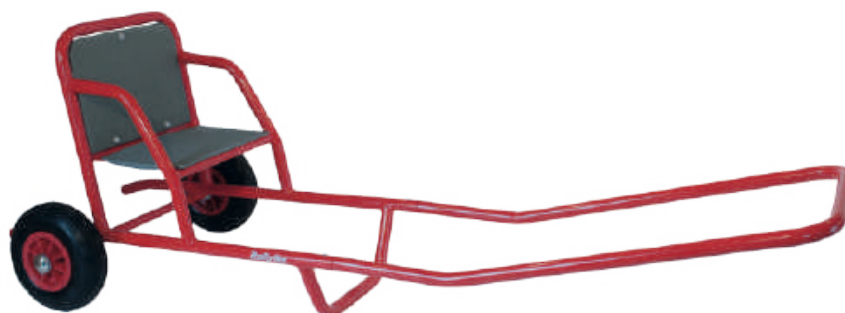



Swing

Mod. 9005

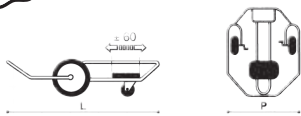

Misura prodotto / Product size
LxHxP 95x71,5 cm 37.40"x23.35"

Imballo / Packaging
Misure/Size 77x28x94 cm 30.32"x11.02"x37.01"
Peso prodotto/Product weight 10,6 kg / 23.37 lbs
Peso con cartone/Shipping weight 13,0 kg / 28.66 lbs
Volume/Volume 0,21 mc / 7.42 cf

Età suggerita/Suggested ages



Peso max/Max user weight 35 kg / 77 lbs

Barcode 8010077900501



Chopper Rear Pu Tires

Mod. 9014

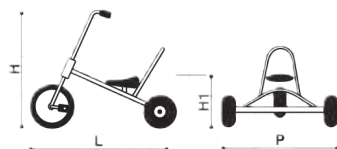

Misura prodotto / Product size
LxHxP 70x91x60 cm 27.56"x35.83"x23.62"
H. SADDLE 34 cm / 13.39"

Imballo / Packaging
Misure/Size 62x53x71 cm 24.41"x20.87"x27.95"
Peso prodotto/Product weight 10,0 kg / 22.05 lbs
Peso con cartone/Shipping weight 12,8 kg / 28.22 lbs
Volume/Volume 0,230 mc / 8.12 cf

Età suggerita/Suggested ages



Peso max/Max user weight 35 kg / 77 lbs

Barcode 8010077901409



Chopper Country Pu Tires

Mod. 9040

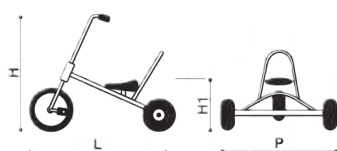

Misura prodotto / Product size
LxHxP 70x91x60 cm 27.56"x35.83"x23.62"
H. SADDLE 34 cm / 13.39"

Imballo / Packaging
Misure/Size 62x53x71 cm 24.41"x20.87"x27.95"
Peso prodotto/Product weight 10,0 kg / 22.05 lbs
Peso con cartone/Shipping weight 12,8 kg / 28.22 lbs
Volume/Volume 0,230 mc / 8.12 cf

Età suggerita/Suggested ages



Peso max/Max user weight 35 kg / 77 lbs

Barcode 8010077904004





Linea Rossa Mini

Linea Rossa Mini is the entry line of walkers, tricycles and scooters dedicated to toddlers.

Ergonomic handlebar for easy and safe riding.

A child's very first tricycle and scooter which help turn first children's movements into real play activities.

Linea Rossa Mini meets CE and ASTM standards.

5 years warranty on frame end fork, also for this entry line.

Replacement parts are readily available.

Linea Rossa Mini is manufactured in Italy.



Steering Limit



Adjustable saddle



Ergonomic Handlebar



Mini Walk 4 Wheels

Mod. 9508

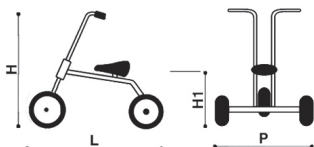

Misura prodotto / Product size

LxHxP 57x28x51cm 22.4"x20"x11"
H. SADDLE 25cm/ 9.8"

Imballo / Packaging

Misure/Size 57x51x25 cm 22.44"x20.08"x7.87"
Peso prodotto/Product weight 5.5kg / 11.9lbs
Peso con cartone/Shipping weight 6.8kg / 14.9 lbs
Volume/Volume 0,073 mc/ 2.58 cf

Età suggerita/Suggested ages



Peso max/Max user weight 20 kg / 44 lbs

Barcode 8010077950803



Mini Walker

Mod. 9501

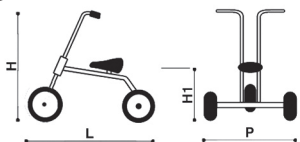

Misura prodotto / Product size

LxHxP 57x28x51cm 22.4"x20"x11"
H. SADDLE I 25cm/ 9.8"

Imballo / Packaging

Misure/Size 64x47x28,5 cm 25.19"x18.50"x22.22"
Peso prodotto/Product weight 5kg / 11lbs
Peso con cartone/Shipping weight 6.4kg / 14lbs
Volume/Volume 0,085 mc/ 3.00 cf

Età suggerita/Suggested ages



Peso max/Max user weight 20 kg / 44 lbs

Barcode 8010077950100



Mini Be Walker

Mod. 9502

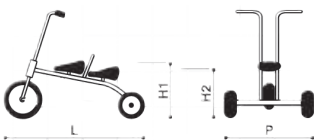

Misura prodotto / Product size

LxHxP 57x87x44 cm 22.44"x33.77"x17.08"
H. SADDLE I 29 cm / 11.25"
H. SADDLE II 25 cm / 17.08"

Imballo / Packaging

Misure/Size 92x46x34 cm 36.22"x18.11"x13.38"
Peso prodotto/Product weight 5,4 kg / 11.88 lbs
Peso con cartone/Shipping weight 6,1 kg / 13.42 lbs
Volume/Volume 0,144 mc/ 5.00 cf

Età suggerita/Suggested ages



Peso max/Max user weight 20 kg / 44 lbs

Barcode 8010077950209





Linea Rossa Mini



Mini Scooter X

Mod. 9505

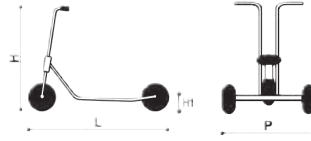

Misura prodotto / Product size

LxHxP 67x61x44 cm 26.00"x23.68"x17.08"
H. I 10 cm / 3.88"

Imballo / Packaging

Misure/Size 61x69x49 cm 23.81"x27.16"x19.29"
Peso prodotto/Product weight 5,4 kg / 11.88 lbs
Peso con cartone/Shipping weight 6,1 kg / 13.42 lbs
Volume/Volume 0,126 mc / 4.46 cf

Età suggerita/Suggested ages



Peso max/Max user weight 20 kg / 44 lbs

Barcode 8010077950506



Mini Scooter Long Base

Mod. 9506

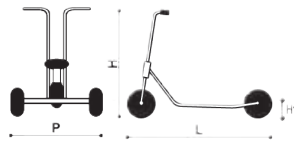

Misura prodotto / Product size

LxHxP 71x85x30cm 27.56"x33.00"x11.64"
H. I 11 cm / 4.27"

Imballo / Packaging

Misure/Size 75x51x37 cm 29.52"x20.07"x14.56"
Peso prodotto/Product weight 5,8 kg / 12.76 lbs
Peso con cartone/Shipping weight 6,5 kg / 14.30 lbs
Volume/Volume 0,141 mc / 5.00 cf

Età suggerita/Suggested ages



Peso max/Max user weight 20 kg / 44 lbs

Barcode 8010077950605





Mini Tricycle

Mod. 9503

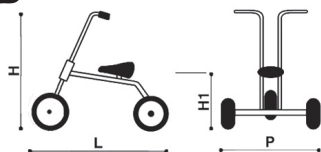

Misura prodotto / Product size

LxHxP 60x65x44 cm 23.29"x25.23"x17.08"
H. SADDLE 30 cm / 11.64"

Imballo / Packaging

Misure/Size 64x47x28,5 cm 25.19"x18.50"x11.22"
Peso prodotto/Product weight 5,4 kg / 11.88 lbs
Peso con cartone/Shipping weight 6,1 kg / 13.42 lbs
Volume/Volume 0,085 mc / 3.00 cf

Età suggerita/Suggested ages



Peso max/Max user weight 20 kg / 44 lbs

Barcode 8010077950308



Mini Touring

Mod. 9504

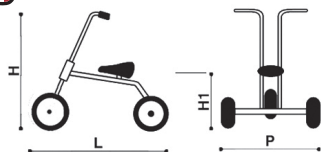

Misura prodotto / Product size

LxHxP 60x65x52 23.29"x25.23"
H. SADDLE 33 cm / 12.81"

Imballo / Packaging

Misure/Size 64x47x28,5 cm 25.19"x18.50"x11.22"
Peso prodotto/Product weight 6,0 kg / 13.20 lbs
Peso con cartone/Shipping weight 6,7 kg / 14.74 lbs
Volume/Volume 0,085 mc / 3.00 cf

Età suggerita/Suggested ages



Peso max/Max user weight 20 kg / 44 lbs

Barcode 8010077950407



Mini Walk Bike

Mod. 9507



Misura prodotto / Product size

LxHxP 92x73 cm 22.83"x28.74"
H. SADDLE 33 cm / 13.00"

Imballo / Packaging

Misure/Size 92x29x38 cm 36.22"x11.41"x14.36"
Peso prodotto/Product weight 4,6 kg / 10.12 lbs
Peso con cartone/Shipping weight 6,0 kg / 13.20 lbs
Volume/Volume 0,101 mc / 3.57 cf

Età suggerita/Suggested ages



Peso max/Max user weight 20 kg / 44 lbs

Barcode 8010077950704





Linea Promo

Promo Series is the new Italtrike proposal for kindergardens, nurseries, day care, facilities and playground. Promo Series is the synthesis of safe, durable, economic and classic tricycles and vehicles for children.

All products meet the latest safety standards in Europe and U.S.A. All products are packed in 2 parts only to assemble.

A complete spare parts service is available, and 5 years warranty on metal parts!

Promo Series comes in a wide range of products and sizes. It is important each child could ride its own sized tricycle.

Linea Promo tricycles are manufactured in Italy.

Frames and forks have 5 years warranty!

Spare parts are readily available.



Steering Limit



Plastic foot step



No rust bearings hub



Walker Mod. 9027



Misura prodotto / Product size
LxHxP 50,5x65,5x44 cm 19,88"x25,78"x17,32"
H. SADDLE 28 cm / 11.02"

Imballo / Packaging
Misura/Size 51x57,5x27 cm 20,08"x22,64"x10,63"
Peso prodotto/Product weight 5,6 kg / 12,34 lbs
Peso con cartone/Shipping weight 6,3 kg / 13,88 lbs
Volume/Volume 0,080 mc / 2,82 cf

Età suggerita/Suggested ages 
Peso max/Max user weight 35 kg / 77 lbs
Barcode 8010077902703



Tricycle Extra Small Mod. 9028



Misura prodotto / Product size
LxHxP 55x68x44 cm 21,65"x26,77"x17,32"
H. SADDLE 32 cm / 15,75"

Imballo / Packaging
Misura/Size 51x57,5x27 cm 20,08"x22,64"x10,63"
Peso prodotto/Product weight 6,4 kg / 14,11 lbs
Peso con cartone/Shipping weight 7,1 kg / 15,65 lbs
Volume/Volume 0,080 mc / 2,82 cf

Età suggerita/Suggested ages 
Peso max/Max user weight 35 kg / 77 lbs
Barcode 8010077902802





Linea Promo



Tricycle Small 10"

Mod. 9022



Misura prodotto / Product size

LxHxP 74x59x51 cm 29.13"x23.2"x20"
 H. SADDLE 31,5 cm / 12.40"

Imballo / Packaging

Misure/Size 56,5x64x32 cm 22.24"x25.20"x12.60"
 Peso prodotto/Product weight 7,2 kg / 15.87 lbs
 Peso con cartone/Shipping weight 7,9 kg / 17.41 lbs
 Volume/Volume 0,115 mc/ 4.06 cf

Età suggerita/Suggested ages



Peso max/Max user weight 35 kg / 77 lbs

Barcode 8010077902208



Tricycle Medium 12"

Mod. 9023

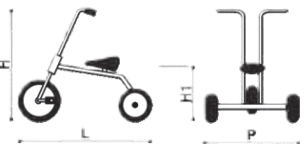

Misura prodotto / Product size

LxHxP 90x66,5x56,5cm 35.4"x26.1"x22.24"
 H. SADDLE 36 cm / 14.17"

Imballo / Packaging

Misure/Size 73x56x39 cm 28.74"x22.05"x15.35"
 Peso prodotto/Product weight 8,2 kg / 18.08 lbs
 Peso con cartone/Shipping weight 8,9 kg / 19.62 lbs
 Volume/Volume 0,167 mc/ 5.90 cf

Età suggerita/Suggested ages



Peso max/Max user weight 35 kg / 77 lbs

Barcode 8010077902307





Tricycle Large 14"

Mod. 9024



Misura prodotto / Product size

LxHxP 90x75x56.5cm 35.4"x29.5"x22.24"
H. SADDLE 41,5 cm / 16.34"

Imballo / Packaging

Misure/Size 56,5x80x37 cm 22.24"x31.50"x14.57"
Peso prodotto/Product weight 8,8 kg / 19.40 lbs
Peso con cartone/Shipping weight 9,5 kg / 20.94 lbs
Volume/Volume 0,167 mc / 5.90 cf

Età suggerita/Suggested ages



Peso max/Max user weight 35 kg / 77 lbs

Barcode 8010077902406



Carry

Mod. 9020

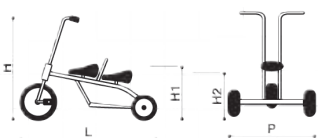

Misura prodotto / Product size

LxHxP 92x61x49cm 36.2"x24"x19.3"
H. SADDLE I 39,5 cm / 15.55"
H. SADDLE II 38,5 cm / 15.15"

Imballo / Packaging

Misure/Size 79x51x45 cm 31.10"x20.07"x17.71"
Peso prodotto/Product weight 10,6 kg / 23.32 lbs
Peso con cartone/Shipping weight 12,6 kg / 27.72 lbs
Volume/Volume 0,181 mc / 6.40 cf

Età suggerita/Suggested ages



Peso max/Max user weight 35 kg / 77 lbs

Barcode 8010077902000



Chopper

Mod. 9041



Misura prodotto / Product size

LxHxP 85x56.5x56.5cm 33.4"x22.24"x22.24"
H. SADDLE 15,5 cm / 6.10"

Imballo / Packaging

Misure/Size 57x67x36 cm 22.40"x26.38"x14.17"
Peso prodotto/Product weight 8,4 kg / 18.59 lbs
Peso con cartone/Shipping weight 9,1 kg / 20.06 lbs
Volume/Volume 0,137 mc / 4.84 cf

Età suggerita/Suggested ages



Peso max/Max user weight 35 kg / 77 lbs

Barcode 8010077904103





Linea Promo



Walk Bike Mod. 9017

Misura prodotto / Product size

LxHxP 88x60.5x42cm 34,6"x23,8"x16,53"
H. SADDLE 38,5 cm / 15,35"

Imballo / Packaging

Misure/Size 47x29x66 cm | 8,50"x11,42"x25,98"
Peso prodotto/Product weight 6,0 kg / 13,20 lbs
Peso con cartone/Shipping weight 7,5 kg / 16,50 lbs
Volume/Volume 0,110 mc / 3,88 cf

Età suggerita/Suggested ages



Peso max/Max user weight 20 kg / 44 lbs

Barcode 8010077901706



Mini Bike Mod. 9018

Misura prodotto / Product size

LxHxP 88x60.5x42cm 34,6"x23,8"x16,53"
H. SADDLE 38,5 cm / 15,35"

Imballo / Packaging

Misure/Size 47x29x66 cm | 8,50"x11,42"x25,98"
Peso prodotto/Product weight 6,4 kg / 14,11 lbs
Peso con cartone/Shipping weight 7,9 kg / 14,42 lbs
Volume/Volume 0,110 mc / 3,88 cf

Età suggerita/Suggested ages



Peso max/Max user weight 20 kg / 44 lbs

Barcode 8010077901805



Bike Mod. 9015

Misura prodotto / Product size

LxHxP 94x72x42cm 37"x28,3"x16,53"
H. SADDLE 47 cm / 18,50"

Imballo / Packaging

Misure/Size 92x29x38 cm | 36,22"x11,42"x14,96"
Peso prodotto/Product weight 7,0 kg / 15,43 lbs
Peso con cartone/Shipping weight 8,5 kg / 18,74 lbs
Volume/Volume 0,110 mc / 3,88 cf

Età suggerita/Suggested ages



Peso max/Max user weight 20 kg / 44 lbs

Barcode 8010077901508





Mini Walk Bike 3 Wheels

Mod. 9054

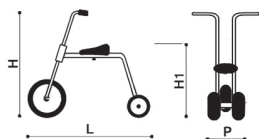

Misura prodotto / Product size

LxHxP 80x53x43cm 31.4"x20.8"x16.9"
H. SADDLE 29 cm / 11.42"

Imballo / Packaging

Misure/Size 57x51x28cm / 22.4"x20"x11"
Peso prodotto/Product weight 5,6 kg / 12.34 lbs
Peso con cartone/Shipping weight 7,1 kg / 15.65 lbs
Volume/Volume 0,073 mc / 2.58 cf

Età suggerita/Suggested ages



Peso max/Max user weight 35 kg / 77 lbs

Barcode 8010077905407



Bike 3 Wheels

Mod. 9055

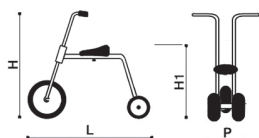

Misura prodotto / Product size

LxHxP 95x72x46cm 37.4"x28.3"x18.1"
H. SADDLE 43 cm / 16.93"

Imballo / Packaging

Misure/Size 92x41x28cm / 36.2"x16.14"x11"
Peso prodotto/Product weight 6,8 kg / 14.99 lbs
Peso con cartone/Shipping weight 8,3 kg / 18.30 lbs
Volume/Volume 0,101 mc / 3.56 cf

Età suggerita/Suggested ages



Peso max/Max user weight 35 kg / 77 lbs

Barcode 8010077905506



Scooter Medium

Mod. 9021

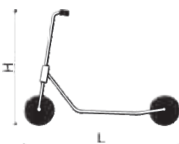

Misura prodotto / Product size

LxHxP 72x104 cm 28.34"x40.95"

Imballo / Packaging

Misure/Size 82x20x44 cm 32.28"x7.87"x17.32"
Peso prodotto/Product weight 6,8 kg / 14.96 lbs
Peso con cartone/Shipping weight 7,8 kg / 15.40 lbs
Volume/Volume 0,080 mc / 2.83 cf

Età suggerita/Suggested ages



Peso max/Max user weight 20 kg / 44 lbs

Barcode 8010077902109





Linea Promo

Fire Truck-Taxi-Ambulance -Police

Mod. 903 1

Misura prodotto / Product size

LxHxP 69x112x50 cm 27.16"x44.48"x19.68"
H. SADDLE 34 cm / 13.38"

Imballo / Packaging

Misure/Size 60x103,5x45 cm 23.62"x40.74"x17.71"
Peso prodotto/Product weight 12 kg / 26.40 lbs
Peso con cartone/Shipping weight 14,6 kg / 32.20 lbs
Volume/Volume 0,280 mc / 9.87 cf

Età suggerita/Suggested ages



Peso max/Max user weight

35 kg / 77 lbs

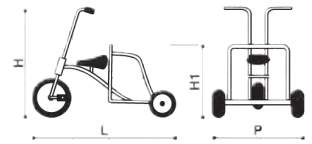

Fire Truck

Mod. 903 1

Barcode 8010077903106



Taxi

Mod. 903 1

Barcode 8010077903113



Ambulance

Mod. 903 1

Barcode 8010077903120



Police

Mod. 903 1

Barcode 8010077903137





Fire Truck - Taxi 1+1 seat

Mod. 9032



Misura prodotto / Product size

LxHxP 69x112x50 cm 27.16"x44.48"x19.68"

H. SADDLE 34 cm / 13.38"

Imballo / Packaging

Misure/Size 60x103,5x45 cm 23.62"x40.74"x17.71"

Peso prodotto/Product weight 12 kg / 26.40 lbs

Peso con cartone/Shipping weight 14,6 kg / 32.20 lbs

Volume/Volume 0,280 mc / 9.87 cf

Età suggerita/Suggested ages



Peso max/Max user weight 35 kg / 77 lbs

Barcode Fire Truck 8010077903205
Taxi 8010077903212



Rishow solid wheels

Mod. 9030PRO



Misura prodotto / Product size

LxHxP 52x130x60 cm 20.47"x51.18"x23.62"

H. Seat 26 cm / 10.24"

Imballo / Packaging

Misure/Size 46x65x80 cm 18.11"x25.59"x31.50"

Peso prodotto/Product weight 9,5 kg / 21.12 lbs

Peso con cartone/Shipping weight 11,0 kg / 24.20 lbs

Volume/Volume 0,239 mc / 8.47 cf

Età suggerita/Suggested ages



Peso max/Max user weight 20 kg / 44 lbs

Barcode 8010077903038

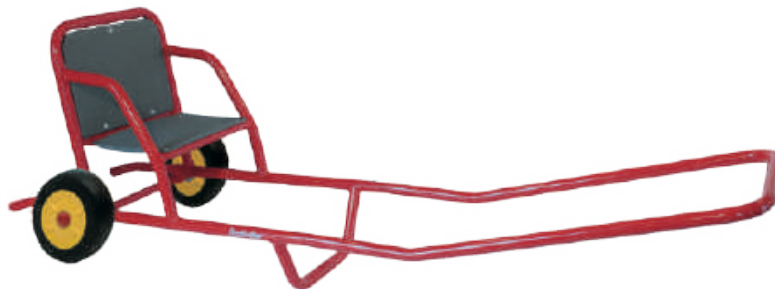



Zero
Italtrike

Zero

The Tricycle with Zero differences

Children with special needs must have the opportunity to enjoy and ride a real tricycle. Italtrike with ZERO follows the "Playtherapy" philosophy.



Zero
Italtrike

Tricycle Zero

Mod. 9800

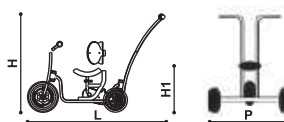

Misura prodotto / Product size

HxLxP 60-74x120x69 cm/23.62"-29.13"x47.24"x27.17"
H1-H2 66-78 cm/25.98"-30.71"

Imballo / Packaging

Misure/Size 52x92x69 cm/20.47"x36.22"x27.17"
Peso prodotto/Product weight 23 kg/50.71 lbs
Peso con cartone/Shipping weight 25 kg/55.16 lbs
Volume/Volume 0,33 mc/11.65 cf

Età suggerita/Suggested ages



Peso max/Max user weight

20 kg/44 lbs

Barcode

8010077980008



Tricycle "ZERO" Ref. 9800ZER990200

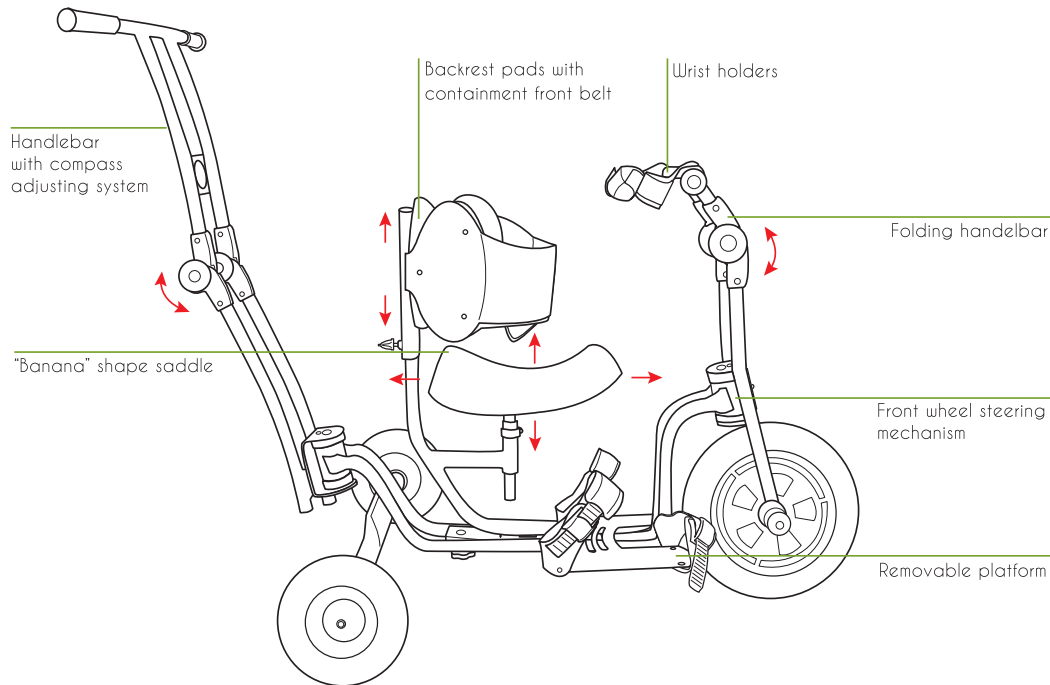

Ergonomy

ZERO with many different regulations of its parts allow to find the most proper position to the child.

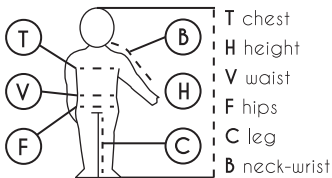

	from cm to cm	from cm to cm	from cm to cm	from cm to cm
H	92-98	98-104	104-110	110-116
T	54-56	56-58	58-60	60-62
V	52-53	53-54	54-55	55-56
F	64-66	66-68	68-70	70-72
C	35-38	38-41	41-44	44-47
B	38-40	40-43	43-46	46-49
age	2-3	3-4	4-5	5-6

Features

- Easy access
- Vertical and horizontal regulation of the seat
- Banana foam seat
- Padded backrest with containment chest belt
- Compass adjusting system of the handlebar
- Compass adjusting system of the handlebar
- Removable support of the lower limbs
- Push handlebar with steering system of the front wheel
- Easy packing system for car loading
- PU puncture-proof tyres

Comfort

ZERO offers a good comfort to the child and allows easy control by his assistant and a wide range of regulation.



Our working experience that brought us today to develop and produce a special line of tricycles dedicated to special children.

Zero is a tricycle that looks like a regular tricycle, Italtrike produce and sell on regular basis. ZERO is a tricycle with ZERO differences, less those to facilitate the utilization to a larger number of children.

The challenge was too important and special to be developed by Italtrike only. We asked the help and collaboration of people with the correct competences and with the spirit to work together with us in this project.

ZERO has been developed thanks to the fantastic help of Mrs. Fosca Fornasei Senior Professor in Metodologia della Riabilitazione in Età evolutiva, at the Verona University, and President of the Association «Gioco Anchio», and of Matteo Mirandola, Mrs. Fornasei University Assistant. Thanks also to Lorenzo, our «test driver» and friend, and to his fantastic parents. But we will never stop to say thanks to all the parents, that in the future could help us in order to improve the tricycle. To make it a more and more valid instrument of play and support for their children.

ZERO will become a line of wheeled vehicles, designed with the purpose to help and facilitate the mobility of children from 2 to 12 years.

ZERO is not a therapeutic instrument, but it is part of the «playtherapy» philosophy. Inclusive products that allow children, with special needs, to gain the «right to play».



Forester

The Italtrike Forester Tricycles Line

Step on a Forester tricycle and you are immediately transported into the forest.

You will find lots of happy and nice friends to play with a Fox, a Rabbit, a Baby Wolf, Deer, a Bear and a Black Wolf...

The traditional sturdiness and quality of Italtrike tricycles combined with a new *eco-friendly* material from Plan Toys, to enter together in the fantastic world of mother nature.

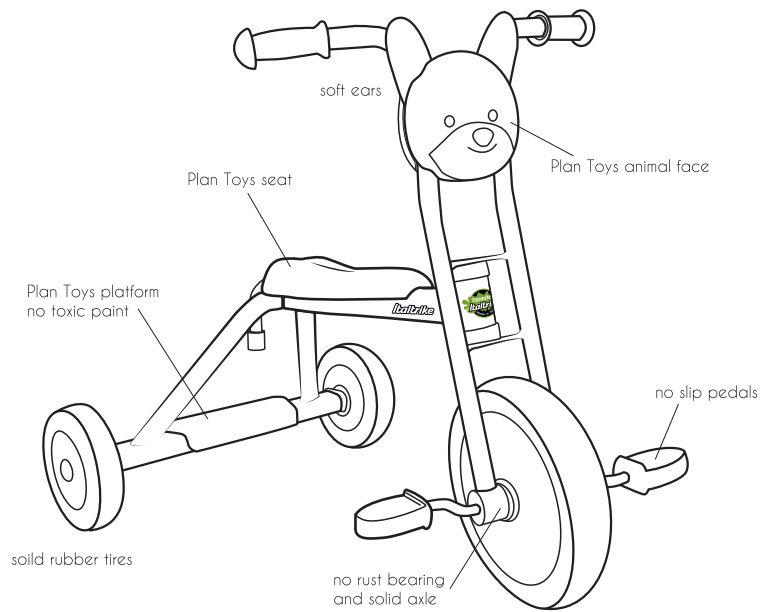



Rabbit Small 10"

Mod. 9700

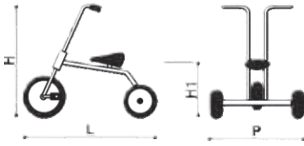

Misura prodotto / Product size

LxHxP 59x74x51 cm 23.23"x29.13"x20.08"
H. SADDLE 31,5 cm / 12.40"

Imballo / Packaging

Misure/Size 56,5x64x32 cm 22.24"x25.20"x12.60"
Peso prodotto/Product weight 7,2 kg / 15.87 lbs
Peso con cartone/Shipping weight 7,9 kg / 17.41 lbs
Volume/Volume 0,115 mc/ 4.06 cf

Età suggerita/Suggested ages

2 4

Peso max/Max user weight 35 kg / 77 lbs

Barcode 8010077970009



Fox Medium 12"

Mod. 9701



Misura prodotto / Product size

LxHxP 66,5x90x56,5 cm 26.18"x35.43"x22.24"
H. SADDLE 36 cm / 14.17"

Imballo / Packaging

Misure/Size 56,5x80x37 cm 22.24"x31.49"x14.56"
Peso prodotto/Product weight 8,2 kg / 18.08 lbs
Peso con cartone/Shipping weight 8,9 kg / 19.62 lbs
Volume/Volume 0,167 mc/ 5.90 cf

Età suggerita/Suggested ages

2 5

Peso max/Max user weight 35 kg / 77 lbs

Barcode 8010077970108



Bear Large 14"

Mod. 9702



Misura prodotto / Product size

LxHxP 75x90x56,5 cm 29.53"x35.43"x22.24"
H. SADDLE 41,5 cm / 16.34"

Imballo / Packaging

Misure/Size 56,5x80x37 cm 22.24"x31.50"x14.57"
Peso prodotto/Product weight 8,8 kg / 19.40 lbs
Peso con cartone/Shipping weight 9,5 kg / 20.94 lbs
Volume/Volume 0,167 mc/ 5.90 cf

Età suggerita/Suggested ages

5 6

Peso max/Max user weight 35 kg / 77 lbs

Barcode 8010077970207





Forester

Forester: the line for nature lovers

A collection of high-quality, environmentally friendly products inspired by tales of woodland animals. A range of products for children aged 2 to 6 years designed to stimulate different abilities in specific age groups. Suitable for kindergartens, playgrounds and domestic environments.



Deer Carry

Mod. 9703

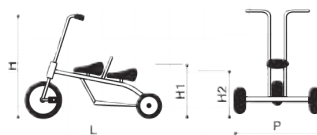

Misura prodotto / Product size

LxHxP	61x92x49 cm	23.81"x36.22"x19.29"
H. SADDLE I		39,5 cm / 15.55"
H. SADDLE II		38,5 cm / 15.15"

Imballo / Packaging

Misure/Size	79x51x45 cm	31.10"x20.07"x17.71"
Peso prodotto/Product weight		10,6 kg / 23.32 lbs
Peso con cartone/Shipping weight		12,6 kg / 27.72 lbs
Volume/Volume		0,181 mc / 6.40 cf

Età suggerita/Suggested ages

3 6

Peso max/Max user weight 35 kg / 77 lbs

Barcode 8010077970306





Baby Wolf Bike

Mod. 9704



Misura prodotto / Product size

LxHxP 60,5x88 cm 24.02"x34.65"
H. SADDLE 38,5 cm / 15.35"

Imballo / Packaging

Misure/Size 92x29x38 cm 36.22"x11.42"x14.96"
Peso prodotto/Product weight 6,4 kg / 14.11 lbs
Peso con cartone/Shipping weight 7,9 kg / 17.41 lbs
Volume/Volume 0,110 mc / 3.88 cf

Età suggerita/Suggested ages

3 6

Peso max/Max user weight 20 kg / 44 lbs

Barcode 8010077970405



Forester





Village Italtrike

Linea Village

Village is Italtrike solution to teach the fundamental rules of road safety to children.

The DVD tutorial makes it simple and fun !

Children are therefore given the opportunity to put into practice what they have learned in the classroom.

The equipment supplied includes the official road signs, working traffic lights (which children can operate themselves), rubber zebra crossing carpets and parking rack.



Parking Rack

Mod. 9414

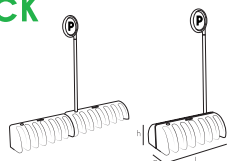

Misura prodotto / Product size
Lxpxh 75x19x25cm / 29.53"x7.48"x9.84"

Imballo / Packaging
Misure/Size 80x25x29cm / 31.50"x9.84"x11.42"
Peso prodotto/Product weight 5,6 kg/ 12,35 lbs
Peso con cartone/Shipping weight 6,9 kg/ 15,21 lbs
Volume/Volume 0,6 cM/ 2,05 cF

Età suggerita/Suggested ages -
Peso max/Max user weight -

Barcode
Green 8010077941405
Red 8010077941412
Cappuccino 8010077941429

Parking Rack for scooters and bicycles.

Parking sign included

Stable base can be filled with water or sand



Available in three color variants.

Green - Red - Cappuccino



1 Product 2 Solutions

In Line

Side to Side



Parking Rack is Registered EU Design Patent N° 005285269

Bus Shelter

Mod. 9405

Bus Stop Shelter

Safe round angles and edges

Stable base can be filled with water or sand

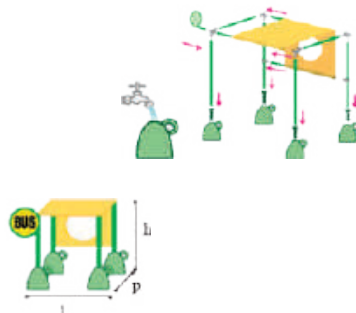

Misura prodotto / Product size
Lxpxh 110x120x110 cm 43.30"x47.24"x43.30"

Imballo / Packaging
Misure/Size 40x80x30 cm 15.74"x31.49"x11.81"
Peso prodotto/Product weight 5,8 kg / 12,76 lbs
Peso con cartone/Shipping weight -
Volume/Volume -

Età suggerita/Suggested ages -
Peso max/Max user weight -

Barcode 8010077940507



Signs + Traffic Light + Zebra + DVD Kit One

Mod. 9418

- 6 Professional copy of official signs
- 1 Traffic Light
- 1 Zebra rubber carpets
- 1 DVD (54 slides)

Stable base can be filled with water or sand

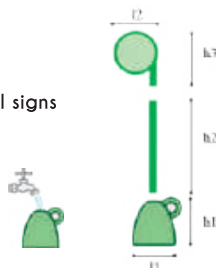

Misura prodotto / Product size

Lxpxh 75x19x25cm / 29.53"x7.48"x9.84"

Imballo / Packaging

Misure/Size 102x42x24cm / 40.15"x16.53"x9.44"

Peso prodotto/Product weight 6.5kg / 14.33 lbs

Peso con cartone/Shipping weight 8kg / 17.63lbs

Volume/Volume 0,6 cM/ 2,05 cF

Età suggerita/Suggested ages -

Peso max/Max user weight -

Barcode

80100779414



Signs + Traffic Light Kit Two

Mod. 9402

Safe round angles

Professional copy of official signs

- 9 Signs
- 1 Traffic Light
- 4 Different country styles



Stable base can be filled with water or sand

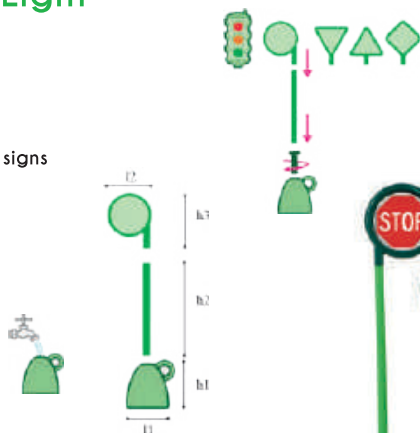

Misura prodotto / Product size

L1 20 cm / 7.87"

L2 14 cm / 5.51"

H1 21 cm / 8.26"

H2 80 cm / 31.50"

H3 35 cm / 13.78"

HT 120 cm / 47.24"

Imballo / Packaging

Misure/Size 102x42x34cm / 40.15"x16.53"x13.38"

Peso prodotto/Product weight 7.5kg/ 16.53 lbs

Peso con cartone/Shipping weight 9.2kg/ 20.28 lbs

Barcode

8010077940200



Traffic Light

Mod. 9403

4 Functional Traffic Light

Can easily be operated by turning the top part

Stable base can be filled with water or sand

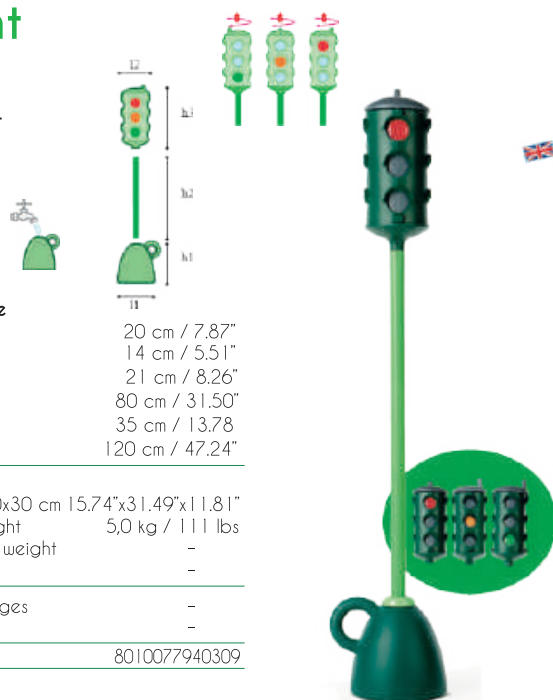

Misura prodotto / Product size

L1	20 cm / 7.87"
L2	14 cm / 5.51"
H1	21 cm / 8.26"
H2	80 cm / 31.50"
H3	35 cm / 13.78"
HT	120 cm / 47.24"

Imballo / Packaging

Misure/Size	40x80x30 cm 15.74"x31.49"x11.81"
Peso prodotto/Product weight	5,0 kg / 11.1 lbs
Peso con cartone/Shipping weight	-
Volume/Volume	-

Età suggerita/Suggested ages

-

Peso max/Max user weight

-

Barcode 8010077940309

DVD Village

Mod. 1975

- La mia prima lezione di guida.
- My very first lessons of driving.
- Mes toutes premières leçons de conduite.
- Meine allerersten lehrungslektionen.
- Mis primeras lecciones de conducta.
- 僕のはじめての運転レッスン!
- Az elsőleckém a vezetésből.
- Moje prve ure prometne vzgoje.
- Mijn allereerste rijles



Zebra Crossing Carpet

Mod. 9404

3 Stop and Zebra rubber carpets

Misura prodotto / Product size

Lxp 200x75 cm / 78.74"x29.52"

Imballo / Packaging

Misure/Size	80x15x15 cm 31.49"x5.90"x5.90"
Peso prodotto/Product weight	3,5 kg / 7.7 lbs

Barcode 8010077940408



Cones

Mod. 9416

24 pcs

Misura prodotto / Product size

Diametro base/Outer dim.	20 cm / 7.87"
Diametro foro/Inner dim.	6 cm / 2.36"
Altezza/Height	5 cm / 1.97"

Imballo / Packaging

Misure/Size	20x21x27cm 7.87"x8.27"x10.36"
Peso prodotto/Product weight	0,8 kg / 1.76 lbs
Peso con cartone/Shipping weight	1 kg / 2.20 lbs

Barcode 8010077941603



Village is offered in 4 different formats to represent the official Road Safety Rules which are applicable in Europe, the United Kingdom and Commonwealth Countries plus USA and Japan.

Village

Mod. 9400

- 1 Metal Wheeled Stroller
- 9 Road Signs
- 1 Functional Traffic Light
- 1 Bus Stop Shelter
- 3 Zebra Rubber Carpets
- 24 Cones
- 1 DVD (54 pages)

Imballo / Packaging

Misure/Size	70x118x52 cm/ 27.55"x46.45"x20.47"
Peso prodotto/Product weight	45 kg / 99 lbs

Barcode 8010077940002





La Cosa

little but makes big things



La cosa is the **first ride-on** which lets the little ones move freely around the house and the kindergarten. Children can easily and intuitively move around, **experiencing different balance sensations** and new motor skills.

It gives the child a sense of freedom, joy, happiness and a great will to move!

La cosa has been conceived and designed **to learn how to coordinate movements while seated.**

Children learn in **complete safety to steer left and right with body movements, using their feet and legs to push and stop.**

Made of robust, safe and sustainable materials.

La cosa is a toy that makes both children and parents happy.

The meaning of its name? with a bit of imagination this ride-on can be whatever you want it to be: a school bus, an ambulance, a fire truck, a police car, a mouse, a crocodile, or even a ladybug. La cosa supports children's imagination to launch themselves into many adventures in complete autonomy.

Get ready to fall in love with it!



la cosa:
FEATURES

SECURITY

COMPLIANT WITH INTERNATIONAL SAFETY REGULATIONS.



ITALTRIKE "SAFETY-FIRST" SECURITY SYSTEMS

LA COSA IS EQUIPPED WITH SECURITY SYSTEMS AS THE ROLLOVER PROTECTION SYSTEM THAT FURTHER INCREASES CHILDREN'S SAFETY.

DESIGN

ICONIC AND ATTRACTIVE DESIGN WITH SINUOUS AND MODERN LINES. CREATED IN COLLABORATION WITH THE PINEAU&LEPORCHES STUDIO IN PARIS.

SMART

LA COSA IS DELIVERED ALMOST ASSEMBLED, A CLICK IN THE HANDLEBARS AND IT IS READY TO RIDE. IT REQUIRES NO MAINTENANCE BUT ONLY OCCASIONAL CLEANING.

LIGHTWEIGHT AND STACKABLE

IT TAKES UP VERY LITTLE SPACE. YOU CAN PILE ONE ON TOP OF THE OTHER PERFECT FOR HOME USE AND KINDERGARTENS.



CUSTOMER SERVICE

PRODUCT CARE INFO AND SPARE PARTS ALWAYS AVAILABLE. BUILT TO LAST.



ITALTRIKE "BRAVO BOX"

100% PAPER FIBER PACKAGING, ZERO ONE-USE PLASTIC.

REGISTERED DESIGN

YOU WILL FALL IN LOVE WITH IT

Indoor use only

CRASH-PROOF PLASTIC, ROUNDED SHAPES

TO AVOID CRAWLING ON WALLS; ITS ROUNDED SHAPES DO NOT DAMAGE FURNITURE AND DOORS.

SAFETY FIRST: ANTI-TIP SYSTEM

EQUIPPED WITH A REAR AND FRONT ANTI-TIP SYSTEM.

SMALL COMPARTMENT UNDER THE SADDLE

TO SECRETLY STORE AND CARRY TOYS AND MANY OTHER THINGS.

SUPPORT HANDLEBARS

TO BE SAFE IN THE SADDLE, IT MAKES THE STEERING INTUITIVE.



RUBBER-COATED WHEELS

TO ADAPT TO ANY SURFACE WITHOUT LEAVING MARKS SUITABLE ON WOODEN FLOORS. SILENT.

FRONT WHEELS TURN 360°

TO BE ABLE TO TURN AND RIDE EVEN IN VERY SMALL PLACES.

SUSTAINABLE

BODY STRUCTURE IN MAPEL RECYCLABLE PLASTIC MADE UP WITH AT LEAST 30% OF RECYCLED POLYMERS.

LIGHT AND COMPACT

STACKABLE UP TO 4 PRODUCTS. SPACE-SAVING, PERFECT FOR HOME USE AND KINDERGARTENS.





La Cosa Animals

Grow up on the move!

Uncompromising design simplicity, perfect proportions for the best functionality, years of carefree rides : that's «la cosa».

Super compact, super handy, several la cosa can be stacked together, which makes it even more suitable for small urban spaces.

Since its launch it is a worldwide success, this is the original, often copied but never equaled ...

Many nice animals to accompany kids in every step of their growth; from the ladybug to the mouse, from the crocodile to the lion and even a tender panda.



La Cosa
Mod. 2000



Misura prodotto / Product size
LxHxP 48x33x21cm 18.9"x12.9"x8.27"
H. SADDLE 21 cm / 8.27"

Imballo / Packaging
Misure/Size 23x50x24cm 9"x19.7"x9.4"
Peso prodotto/Product weight 2,5 kg
Peso con cartone/Shipping weight 3 kg
Volume/Volume 0,0267mc

Imballo multiplo 4pz / Master carton 4 pcs
Misure/Size 51x47x46cm
Peso con cartone/Shipping weight 13kg

Età suggerita/Suggested ages 1-6 years
Peso max/Max user weight 50 kg



Ladybug

2000LBI

Cod. 2000LBI990001

Barcode

8010077200069



Lion

2000LIO

Cod. 2000LIO990001

Barcode

8010077200007



Crocodile

2000COC

Cod. 2000COC990001

Barcode

8010077200083



Panda

2000PAN

Cod. 2000PAN990001

Barcode

8010077200090



Mouse

2000MOU

Cod. 2000MOU990001

Barcode

8010077200076





La Cosa Vehicles



Why la cosa?

It's a Trainer for Kids

Kids learn equilibrium, stability and how to push and stop with legs. Our objective was to let kids move on wheels safely even indoor.

Resistant

La Cosa has been tested and is resistant to 50 Kilos. This Italian product stands out for its great functionality, durability and a timeless design. Its longevity is the core of the product's contribution to sustainable development.

Silent and clean indoor

Smooth, maintenance-free, highly reliable thanks to special ABEC industry standard ball bearings and completely silent for the solid rubber wheels. The top quality rubber wheels guarantee total silence and do not leave any marks or scratch on the floor.

Funny

The two front wheels have full 360° rotation, while the two rear wheels are fixed, so let kids move and enjoy riding La Cosa 1 even in very small rooms. Moreover in the storage compartment they can take their favourite treasures and small toys with them.





La Cosa Mod. 2000



Misura prodotto / Product size

LxHxP 48x33x21cm 18.9"x12.9"x8.27"
H. SADDLE 21 cm / 8.27"

Imballo / Packaging

Misure/Size 23x50x24cm 9"x19.7"x9.4"
Peso prodotto/Product weight 2,5 kg
Peso con cartone/Shipping weight 3 kg
Volume/Volume 0,0267 mc

Imballo multiplo 4pz / Master carton 4 pcs

Misure/Size 51x47x46cm
Peso con cartone/Shipping weight 13kg

Età suggerita/Suggested ages

1-6 years
Peso max/Max user weight 50 kg

Fire Truck

2000FTR

Cod. 2000FTR990001

Barcode

8010077200045



La Cosa

Police

2000POL

Cod. 2000POL990001

Barcode

8010077200052



California Dreams

2000VAN

Cod. 2000PCO990001

Barcode

8010077200014



Ambulance

2000AMB

Cod. 2000AMB990001

Barcode

8010077200021



Taxi

2000TAX

Cod. 2000POL990001

Barcode

8010077200038



Indoor use only

87



La Cosa 2

learn & Ride!

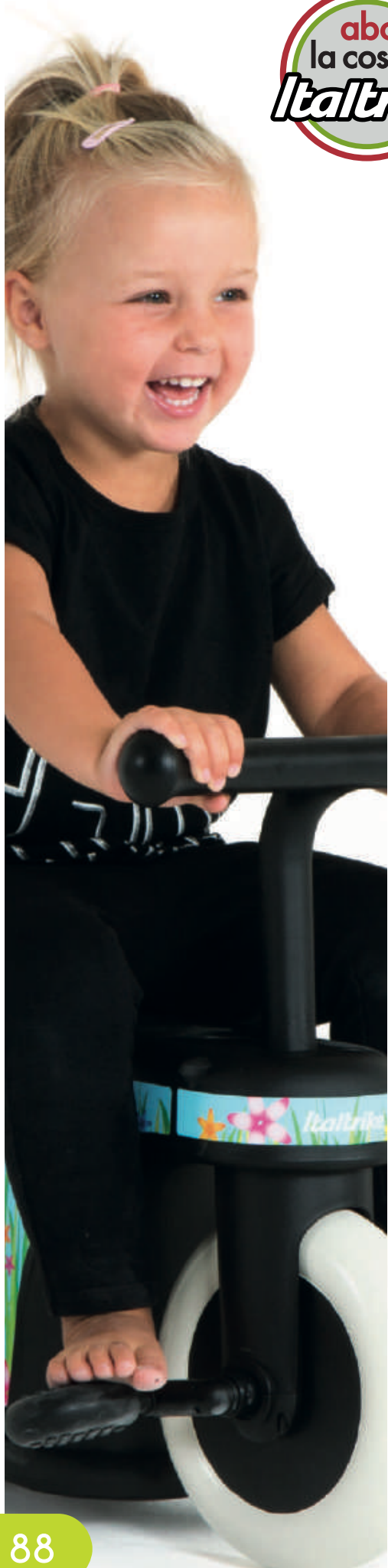

A great product for the very first ride. Easy to push and roll by the kid to develop his/her gross motor skills. Pedals can be easily fixed on the front wheel to be quickly used by the kid.

The perfect tricycle to use indoor, in the safest place in the world, your own home. Children like to move, children like to ride, children like La Cosa!

It's easy! in 3 steps, from a ride on into a tricycle



Ride-on

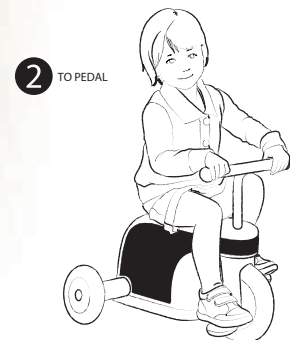
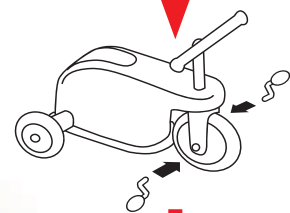
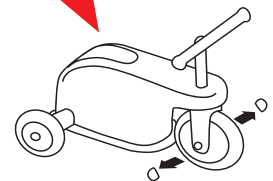
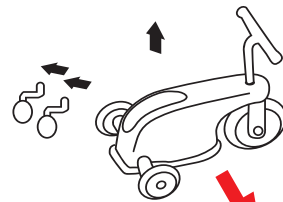

Tricycle



We will grow up together!



La Cosa 2

Mod. 3200

Misura prodotto / Product size

LxHxP 47,5x21x29 cm 18,70"x8,27"x11,42"
H. SADDLE

Imballo / Packaging

Misure/Size 59x25x30 cm 23,23"x9,84"x11,81"
Peso prodotto/Product weight 5,0 kg / 11,02 lbs
Peso con cartone/Shipping weight
Volume/Volume

Imballo multiplo 2 pz / Master Carton Packaging

Misure/Size 61x32x52 cm
Peso con cartone/Shipping weight 10,7 kg

Età suggerita/Suggested ages

1 3

Peso max/Max user weight

35 kg / 77 lbs

Farmer

3200FAR

Cod. 3200FAR990000

Barcode

8010077320064



Chopper

3200CHO

Cod. 3200CHO990000

Barcode

8010077320071



Dragster

3200DRA

Cod. 3200DRA990000

Barcode

8010077320057



Scooter Red

3200SCR

Cod. 3200SCR990000

Barcode

8010077320088



Flower

3200FLW

Cod. 3200FLW990000

Barcode

8010077320040





Gioca

Kids on 4 wheels

Gioca is an unique line of adjustable skates. Traditional skates, children can wear directly on their own shoes. Easy to adjust by a simple click. Manufactured in Italy, Gioca skates are made by technical polymers.

BAMBI, the entry line, for shoes size 24 to 34. MINI JET, for shoes size 24-36, reinforced frame, wheels with ball bearing, front rubber integrated brake, Soft foot neck collar and quick release straps. JET, for big boys, fit shoes 34 to 44.



"Italtrike BRAVO BOX"
100% RECYCLED AND RECYCLABLE PAPER FIBER PACKAGING



Bambi
Mod. IGB 100



Max user weight



Suggested ages



Size

Accessories

- Plastic adjustable frame
- Quick release
- Soft feet protection
- Integrated front brakes
- Wheels 50x30 mm
- Backward wheels safety system



Bambi "Green"
IGB 100-B
8010077985010

Bambi "Girl"
IGB 100-G
8010077985027



Mini Jet
Mod. IGM 215

Accessories

- Reinforced plastic frame
- Quick release strap
- Soft feet protection
- Integrated rubber brakes
- 2 ball bearing on each wheel
- Wheels 50x30 mm

Max user weight
 Suggested ages
 Size

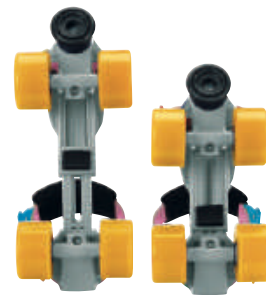

Mini Jet "Green"
IGM 215-B
8010077985164

Mini Jet "Pink"
IGM 215-G
8010077985171



Jet
Mod. IGJ 251

Accessories

- Plastic adjustable frame
- Quick release
- Soft feet protection
- Integrated front brakes
- Wheels 50x30 mm
- Backward wheels safety system

Max user weight
 Suggested ages
 Size



Jet "Red Blue"
IGJ 251-B
8010077985119

Jet "Pink"
IGJ 251-G
8010077985133

Alutrike Spare Parts



Model	Front Wheel	Rear Wheels	Rear wheel Fittings	Pedal	Axle	Steering Bolt	Steering Washer	Axle Washer	Seat	Grips	Platform
2001(old)	2330	23620015	2477	2332	204799	1119+1144	162400	162500	162109+162209	161400	162709
2001(2012)	2330	23620015	2477	2332	204799	1119+1144	162400	162500	507800	161400	162709
2002(old)	2330	23620015	2477	2332	204799	1119+1144	162400	162500	162109+162209	161400	162615
2002(2012)	2330	23620015	2477	2332	204799	1119+1144	162400	162500	507800	161400	162615
2003SW	2331F	2331R	164900	----	----	1119+1144	162400	----	----	161400	162709
2003PU	515715	515715	164900	----	----	1119+1144	162400	----	----	161400	162709
2005PU	515715	515715	162000	----	----	1119+1144	162400	----	507800	161400	----
2005SW	2331F	2331F	----	----	----	1119+1144	162400	----	507800	161400	----

Pilot Spare Parts



Model	Front Wheel	Rear Wheels	Rear wheel Fittings	Front wheel Fittings	Steering Bolt	Steering Restrictor	Steering Cover	Pedal	Rear Axle	Saddle	Platform	Frame Cup	Handlebar "Dynamic"	Back Rest "Dynamic"	Handlebar Back Rest
100-01	23650015	23620015	2472	2467	2468	166400	2470	----	204299	132400	----	167000	520600	522800	522900
100-02	23640015	23620015	2472	----	2468	166400	2470	2332	204299	132400	----	167000	520600	522800	522900
100-03	23650015	23620015	2472	2467	2468	166400	2470	----	204299	132400	----	167000	520600	522800	522900
100-04	23650015	23620015	2474	2467	2468	166400	2470	----	204399	----	167200	168300	520600	----	----
200-07	23380015	23620015	2475	----	2468	166400	2470	2332	204799	2471	----	167000	520600	522800	522900
200-10	23380015	23620015	2475	----	2468	166400	2470	2332	204799	2471	166100	167000	520600	522800	522900
200-11	23410015	23430015	2466	2467	2468	166400	2470	----	200099	----	167200	168300	520600	----	----
200-17	23380015	23410015	2467	----	2468	166400	2470	2332	----	132400	----	167000	520600	522800	522900
200-20	23410015	23410015	2467	2467	2468	166400	2470	----	----	132400	----	167000	520600	522800	522900
300-14	23390015	23620015	2475	----	2468	166400	2470	2332	204799	2471	----	167000	520600	522800	522900
300-15	23390015	23620015	2475	----	2468	166400	2470	2332	204799	2471	166100	167000	520600	522800	522900
300-17	23390015	23420015	2467	----	2468	166400	2470	2332	----	132400	----	167000	520600	522800	522900
300-18	23420015	23430015	2466	2467	2468	166400	2470	----	200099	----	167200	168300	520600	----	----
300-19	23390015	23620015	2475	----	2468	166400	2470	2332	204799	2471	166100	167000	520600	----	----
300-19 (1+2)	23390015	23620015	2493	----	2468	166400	2470	2332	350999	2471	166100	167000	520600	----	----
300-19 (1+1)	23390015	23620015	2475	----	2468	166400	2470	2332	204799	2471	166100	167000	520600	----	----
300-21	23420015	23130015	5039	2467	2468	166400	2470	----	351599	----	261800 261900	168300	520600	----	522900

Eolo Spare parts

EOLO Triciclo - parti di ricambio / Tricycle - spare parts / Tricycle - Pièces de rechange / Dreirad - Ersatzteile

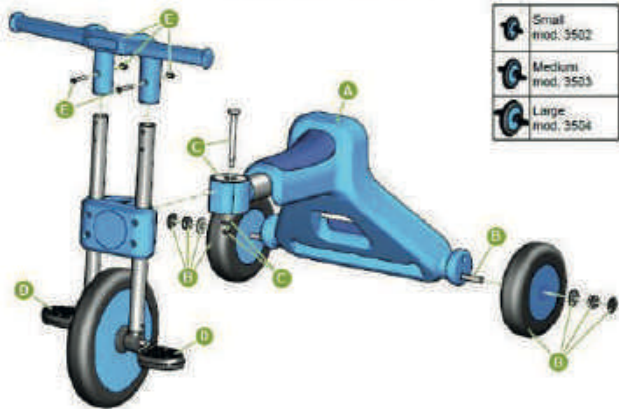

Component	Code	N.
A Telaio / Frame / Cadre / Rahmen	520092	1
Kit ruote "taglia S" mod. 3502 / Kit of wheels "size S" mod. 3502 / Kit de roues « taille S » mod. 3502 / Rädersatz „Größe S“ Mod. 3502	3599	1
Kit ruote "taglia M" mod. 3503 / Kit of wheels "size M" mod. 3503 / Kit de roues « taille M » mod. 3503 / Rädersatz „Größe M“ Mod. 3503	3598	1
Kit ruote "taglia L" mod. 3504 / Kit of wheels "size L" mod. 3504 / Kit de roues « taille L » mod. 3504 / Rädersatz „Größe L“ Mod. 3504	3597	1
C Kit vite sterzo / Steering pin kit / Kit de vis de direction / Lenkerschraubensatz	2457	1
D Pedali / Pedals / Pédales / Pedale	2332	2
E Kit manubrio / Handlebars kit / Kit de guidon / Lenkersatz	3591	1

EOLO 2 posti (mod. 3506) - parti di ricambio / 2-seater (mod. 3506) - spare parts / 2 places (mod. 3506) - Pièces de rechange / Zweisitzer (Mod. 3506) - Ersatzteile

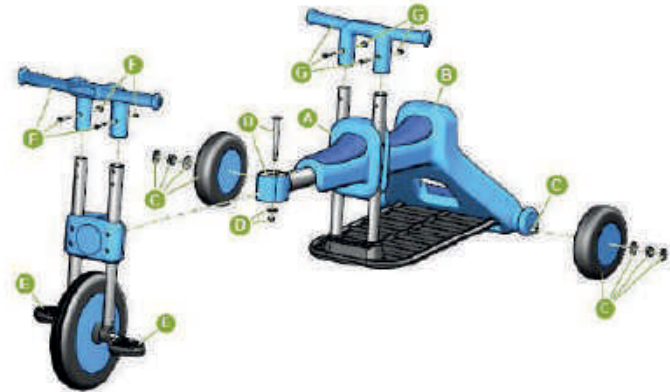

Component	Code	N.
A Telaio anteriore / Front frame / Cadre avant / vordere Rahmen	520192	1
B Telaio posteriore / Rear frame / Cadre arrière / hinterer Rahmen	520092	1
C Kit ruote / Kit of wheels / Kit de roues / Rädersatz	3597	1
D Kit vite sterzo / Steering pin kit / Kit de vis de direction / Lenkerschraubensatz	2457	1
E Pedali / Pedals / Pédales / Pedale	2332	2
F Kit manubrio anteriore / Front handlebars kit / Kit de guidon avant / vorderer Lenkersatz	3591	1
G Kit manubrio posteriore / Rear handlebars kit / Kit de guidon arrière / hinterer Lenkersatz	3590	1

EOLO Bike - parti di ricambio / spare parts / Velo sans pédales - Pièces de rechange / Ersatzteile

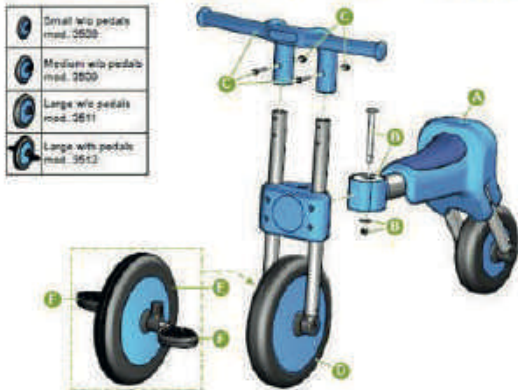

Component	Code	N.
A Telaio / Frame / Cadre / Rahmen	520292	1
B Kit vite sterzo / Steering pin kit / Kit de vis de direction / Lenkerschraubensatz	2457	1
C Kit manubrio / Handlebars kit / Kit de guidon / Lenkersatz	3591	1
Kit ruote senza pedali "taglia S" mod. 3508 / Kit of wheels without pedals "size S" mod. 3508 / Kit de roues sans pédales « taille S » mod. 3508 / Rädersatz ohne Pedalen „Größe S“ Mod. 3508	3596	1
Kit ruote senza pedali "taglia M" mod. 3509 / Kit of wheels without pedals "size M" mod. 3509 / Kit de roues sans pédales « taille M » mod. 3509 / Rädersatz ohne Pedalen „Größe M“ Mod. 3509	3595	1
Kit ruote senza pedali "taglia L" mod. 3511 / Kit of wheels without pedals "size L" mod. 3511 / Kit de roues sans pédales « taille L » mod. 3511 / Rädersatz ohne Pedalen „Größe L“ Mod. 3511	3594	1
Kit ruote con pedali "taglia L" mod. 3512 / Kit of wheels with pedals "size L" mod. 3512 / Kit de roues avec pédales « taille L » mod. 3512 / Rädersatz mit Pedalen „Größe L“ Mod. 3512	3597	1
F Pedali / Pedals / Pédales / Pedale	2332	2

Eolo, 100% recyclable tricycle

Recyclable materials

Tricycle designed and built the EOLO tricycles in observance of current recycling and eco-sustainable criteria.

At the end of its life the tricycle can easily be completely broken down into its various parts for recycling. The types of materials used on the tricycle are listed below, with the relevant recycling codes.

Code	Type of material	Code	Type of material
♻️	Plastic	♻️	Iron and steel

The materials must be disposed of in accordance with the local regulations in force on waste collection.

Disposing of packaging

All the packaging can be recycled. The types of materials used in the packaging are listed below, with the relevant recycling codes.

Code	Type of material
♻️	Large and small cardboard
♻️	Large and small boxes

The materials must be disposed of in accordance with local regulations in force on waste collection.

Linea Rossa Spare parts

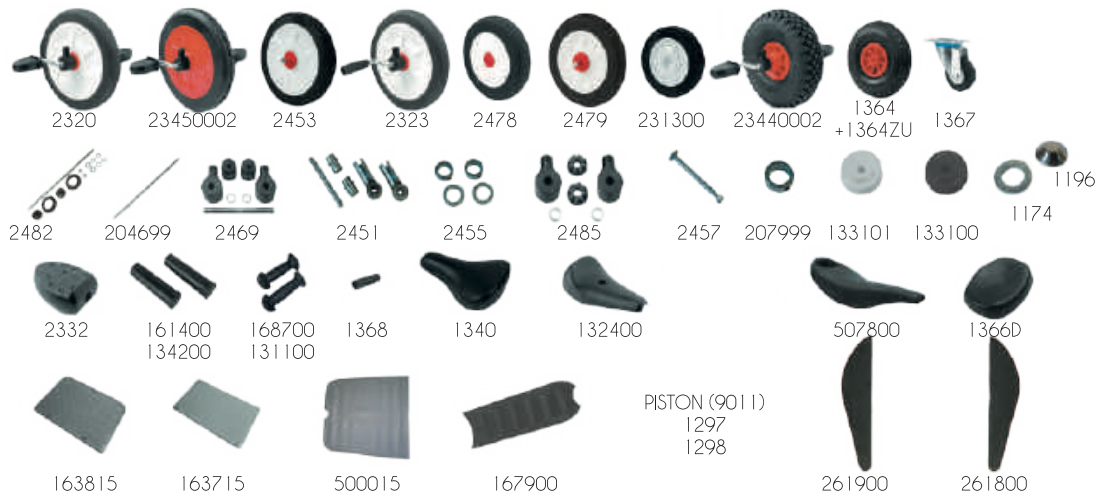

Model	Front Wheel	Rear Wheels	Rear wheel Fittings	Pedal	Axle	Steering Bolt	Steering Washer	Saddle	Grips	Platform
9001	2320	231300	2482	2332	204699	2457	133101	1340	161400	----
9002	2320	231300	2482	2332	204699	2457	133101	1340	161400	500015
9003	2320	231300	2482	2332	204699	2457	133101	1340	161400	163715+163815
9004	2478	2478	2469	----	200099	2457	133101	----	168700	167900
9005	2323	1367	----	----	----	----	----	1366D	1368	163715
9006	----	231300	2482	----	204699	----	----	----	----	163715+163815
9007/08	1364	1364	2451	----	206499	2457	133100	----	131100	167900
9010	23450002	1364ZU	2455	2332	----	2457	133101	1340	161400	500015
9011	23450002	1364ZU	2455	2332	----	207999	130400	1366D	134200	----
9014	23450002	1364ZU	2455	2332	----	2457	133101	507800	161400	----
9015	2320	2453	2485	2332	----	2457	133101	507800	161400	----
9017	2453	2453	2485	----	----	2457	133101	507800	161400	----
9018	2320	2453	2485	2332	----	2457	133101	507800	161400	----
9021	2479	2479	2485	----	----	2457	133101	----	168700	167900
9030	----	1364	1174+1196	----	----	----	----	----	----	163715+163815
9040	23440002	1364ZU	2455	2332	----	2457	133101	507800	161400	----
9050/51	1364	1364	----	----	----	2457	133100	----	168700	261800+261900
9053	2453	231300	5039	----	351599	2457	133101	----	168700	261800+261900
9058	230400	----	1111+1122	----	----	----	----	----	131100	----
9059	----	231300	2475	----	204799	----	----	----	----	166100
9060	2320	231300	2493	2332	350999	2457	133101	1340	161400	163715+163815

Linea Rossa MINI Spare parts



Model	Front Wheel	Rear Wheels	Rear wheel Fittings	Pedal	Axle	Steering Bolt	Steering Washer	Saddle	Handle-bar	Platform
9501	23650015	23130015	2472	----	204299	2484	130400	132400	506300	----
9502	23650015	23130015	2472	----	204299	2484	130400	132400	506300	----
9503	248115	23130015	2472	2332	204299	2484	130400	132400	506300	----
9504	248115	23130015	2482	2332	204699	2484	130400	131500	506300	----
9505	23650015	23130015	2472	----	204299	2484	130400	----	506300	261500
9506	23650015	23130015	2474	----	204399	2484	130400	----	506300	167900
9507	23650015	23650015	2485	----	----	2484	130400	132400	506300	----

Promo Spare parts

247805



Model	Front wheel	Rear wheels	Rear wheel fittings	Pedal	Axle	Steering Bolt	Steering Washer	Saddle	Grips	Platform
9020	232005	23130005	2483	2332	204799	2457	133100	507800	161400	500015
9022	248105	23130005	2488	2332	204299	2457	133100	507800	161400	506400
9023	232005	23620005	2483	2332	204799	2457	133100	507800	161400	506400
9024	23450005	23620005	2483	2332	204799	2457	133100	507800	161400	506400
9027	23620005	23130005	2488	----	207499	2457	133100	507800	161400	506400
9028	248105	23130005	2488	2332	207499	2457	133100	507800	161400	506400
9029	232005	23130005	2472	2332	204299	2457	133100	507800	161400	----
9030PRO	----	23130005	----	----	204799	----	----	----	----	163715+/163815
9031AM	23450001	231300	2483	2332	204799	2457	133100	507800	161400	500015T
9031FT	23450005	23130005	2483	2332	204799	2457	133100	507800	161400	500015T
9031PO	23450001	231300	2483	2332	204799	2457	133100	507800	161400	500015T
9031TA	23450005	23130005	2483	2332	204799	2457	133100	507800	161400	500015T
9032FT	23450005	23130005	2483	2332	204799	2457	133100	507800	161400	500015T
9032TA	23450005	23130005	2483	2332	204799	2457	133100	507800	161400	500015T
9041	23450005	23620005	2483	2332	204799	2457	133100	132400	161400	----

Forest Spare parts

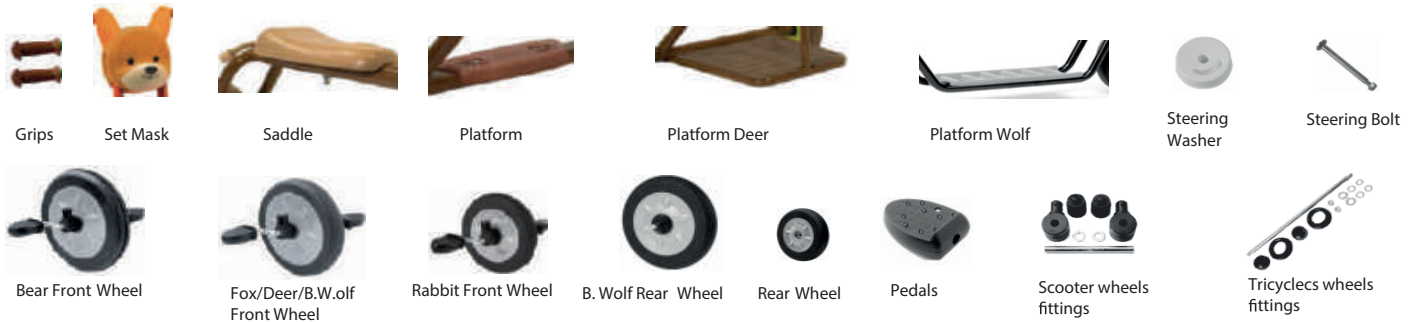

Model	Front Wheel	Rear Wheels	Front wheel Fittings	Rear wheel Fittings	Pedal	Steering Bolt	Steering Washer	Saddle	Grips	Platform	Set Mask
RABBIT 9700	S021	S025	/	2488	S029	2457	133144	S030	133644	S036	S010
FOX 9701	S020	S025	/	2483	S029	2457	133144	S031	133644	S037	S011
BEAR 9702	S023	S026	/	2483	S029	2457	133144	S032	133644	S038	S012
DEER 9703	S020	S025	/	2483	S029	2457	133144	S033F+ S033R	133644	500044	S013
BABY WOLF 9704	S022	S027	/	S028	S029	2457	133144	S034	133644	/	S014
WOLF 9705	S024	S024	S035	S035	/	2457	133144	/	133644	167900	S015

La Cosa 2 Spare parts

La Cosa 2 Stickers

Model	Sticker Code
Farmer	6703
Chopper	6704
Scooter	6705
Dragster	6706
Flower	6707



La Cosa Spare parts

La Cosa 1 Stickers

Model	Sticker Code
Fire Truck	1771
Ambulance	1772
Police	1773
Taxi	1774
Pink Combi	1775
Ladybug	1776
Mouse	1777
Crocodile	1778
Panda	1779
Lion	6702
Koala	
Vintage Touring	



READY FOR TOMORROW!

FOR CHILDREN, MOVEMENT MEANS WELL-BEING, GROWTH, MOTOR AND INTELLECTUAL DEVELOPMENT. THANKS TO ACTIVITIES AND PLAYING, CHILDREN LEARN AND GROW UP. THEY BECOME AWARE OF THEIR OWN BODY IN RELATION TO SPACE AND THEIR PLAYMATES.

OUR MISSION? TO PUT CHILDREN'S WELL-BEING AT THE HEART OF OUR PRODUCTS.

TO INNOVATE THE MARKET FOR CHILDREN'S RIDE-ONS, TRICYCLES AND WHEELED-TOYS THROUGH PRODUCTS OF THE HIGHEST QUALITY, 100% MADE IN ITALY, PRODUCED RESPECTING PEOPLE AND ENVIRONMENT, WITH A UNIQUE DESIGN CONCEIVED TO LAST. TO ENSURE THE DEVELOPMENT, GROWTH AND JOY OF OUR KIDS.

Italtrike
kids on wheels

ITALTRIKE SRL - Via Piovega 49
31017 Pieve del Grappa (TV) - Italy
Tel. +39 0423 946400 - info@italtrike.com

ITALTRIKE.COM

Discover
Italtrike world!

